

# Claves de Éxito en IoT para la



# Transformación Digital

---

---

Jorge Finochietto  
*21 de abril de 2022*



# 2022

# Internet

# of

# ?



# Internet Users

2022: 4.9K millions users (~60%)

6 out 10 persons have Internet access

Users have doubled in only 10 years

Grow rate of 3-4% per year

Internet penetration non-uniform

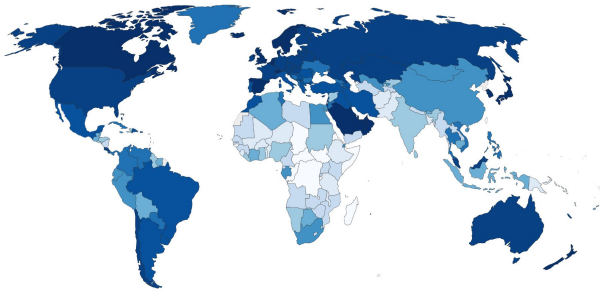

## Individuals using the Internet

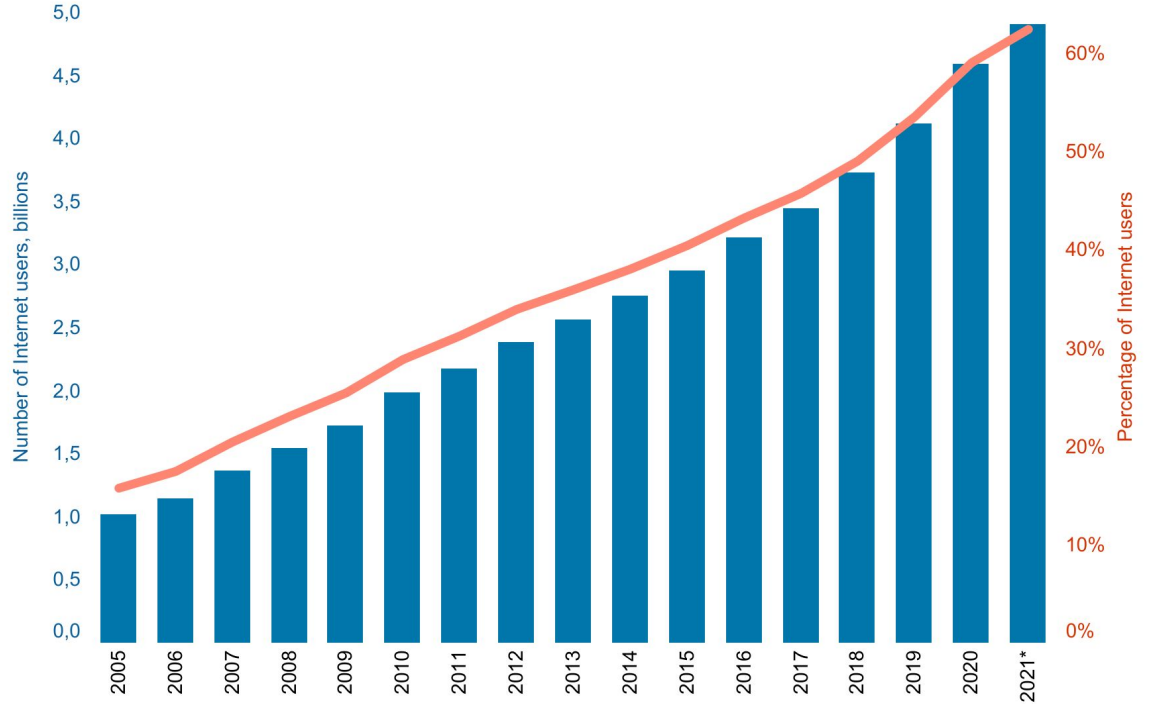

Source: ITU  
\* ITU estimate

# Fixed Access

Fixed access not growing

3 persons per access in developed

10 persons in developing

100 persons in least developed

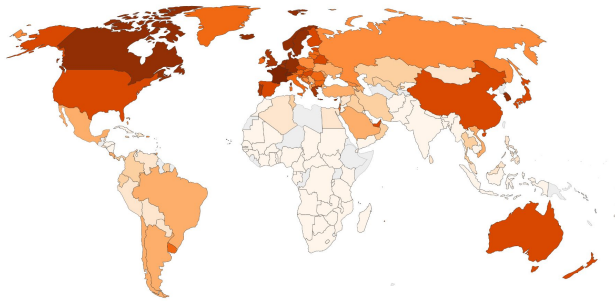

Fixed-broadband subscriptions per 100 inhabitants, by development status

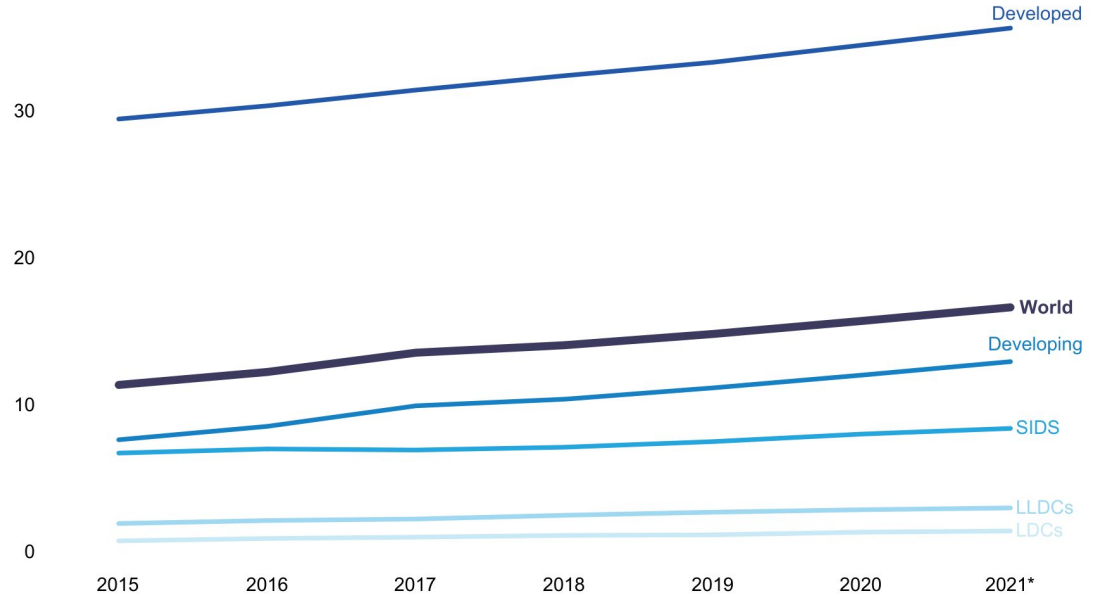

Select measure:

- Fixed-telephone subscriptions per 100 inhabitants
- Fixed-broadband subscriptions per 100 inhabitants
- Mobile-cellular telephone subscriptions per 100 inhabitants
- Active mobile-broadband subscriptions per 100 inhabitants

Source: ITU  
\* ITU estimate

# Mobile Access

More than 1 mobile access per person in developed countries

About 1 mobile access every 3 persons in least developed countries

Mobile access has double in 5 years

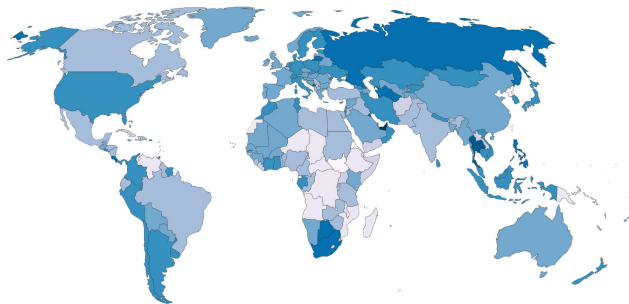

Active mobile-broadband subscriptions per 100 inhabitants, by development status

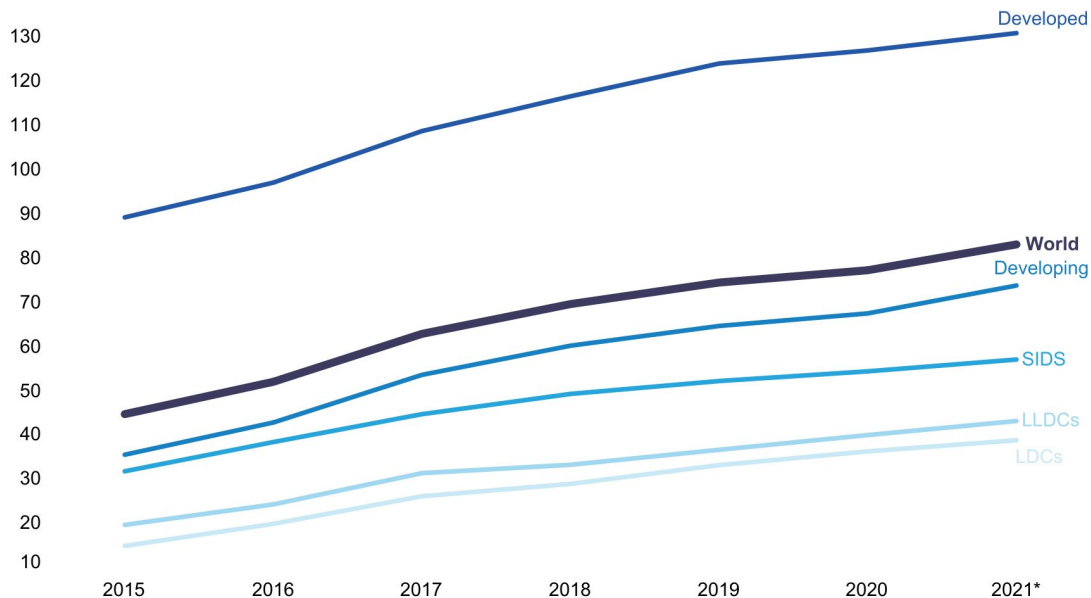

Select measure:

- Fixed-telephone subscriptions per 100 inhabitants
- Fixed-broadband subscriptions per 100 inhabitants
- Mobile-cellular telephone subscriptions per 100 inhabitants
- Active mobile-broadband subscriptions per 100 inhabitants

# 2022

**Internet**

**4.9K millions**



**of**



**People**

**7.9K millions**

# Internet Devices

Personal Devices



Non-Personal Devices



# Internet Devices

## Personal Devices



## Non-Personal Devices





# Internet Devices

## Personal Devices



## Non-Personal Devices



# Devices connected to Internet

2022: More non-personal devices that personal ones (~50% more)

Saturation of personal devices

Exponential growth of non-personal devices (~13% per year)

Expected more than 50K millions of non personal devices by 2030 (about 6 times world's population)

Non-personal devices can be any "Thing" connected to the Internet

Internet not only connects people but also things

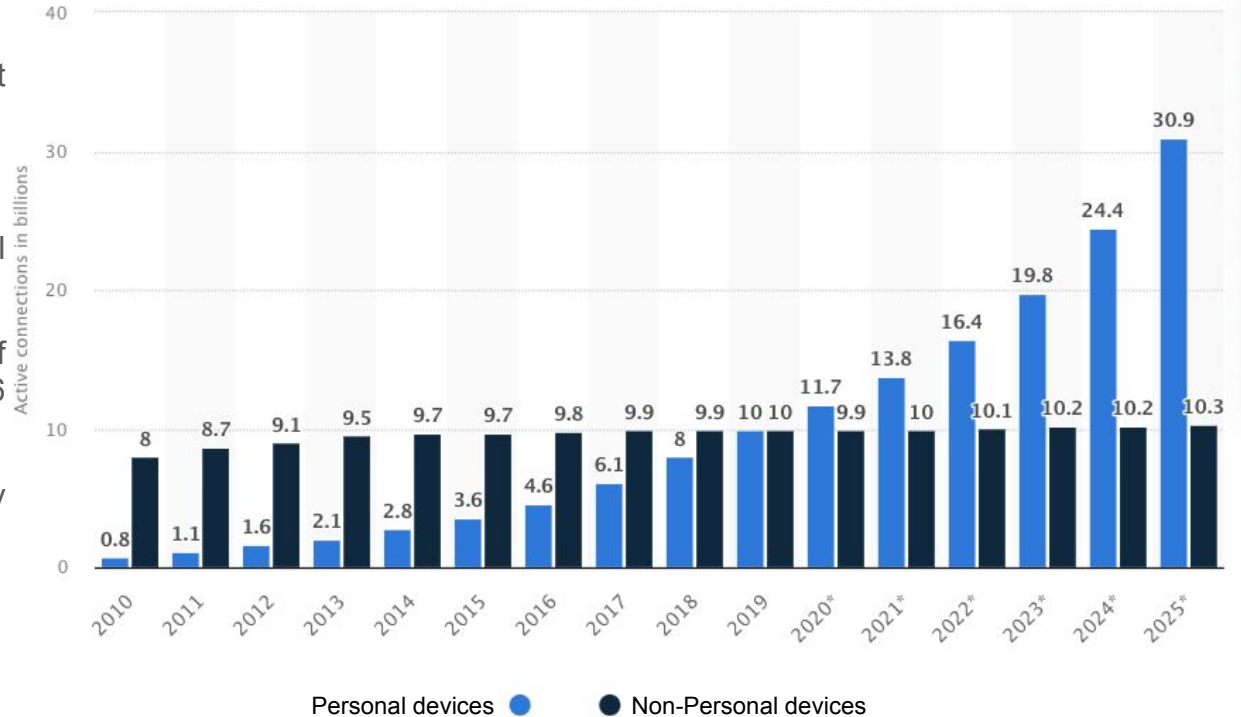

# 2022

**Internet**

4.9K millions

**of**

**People**

7.9K millions

**Internet**

26.5K millions

**of**

**Things**

16.4K millions

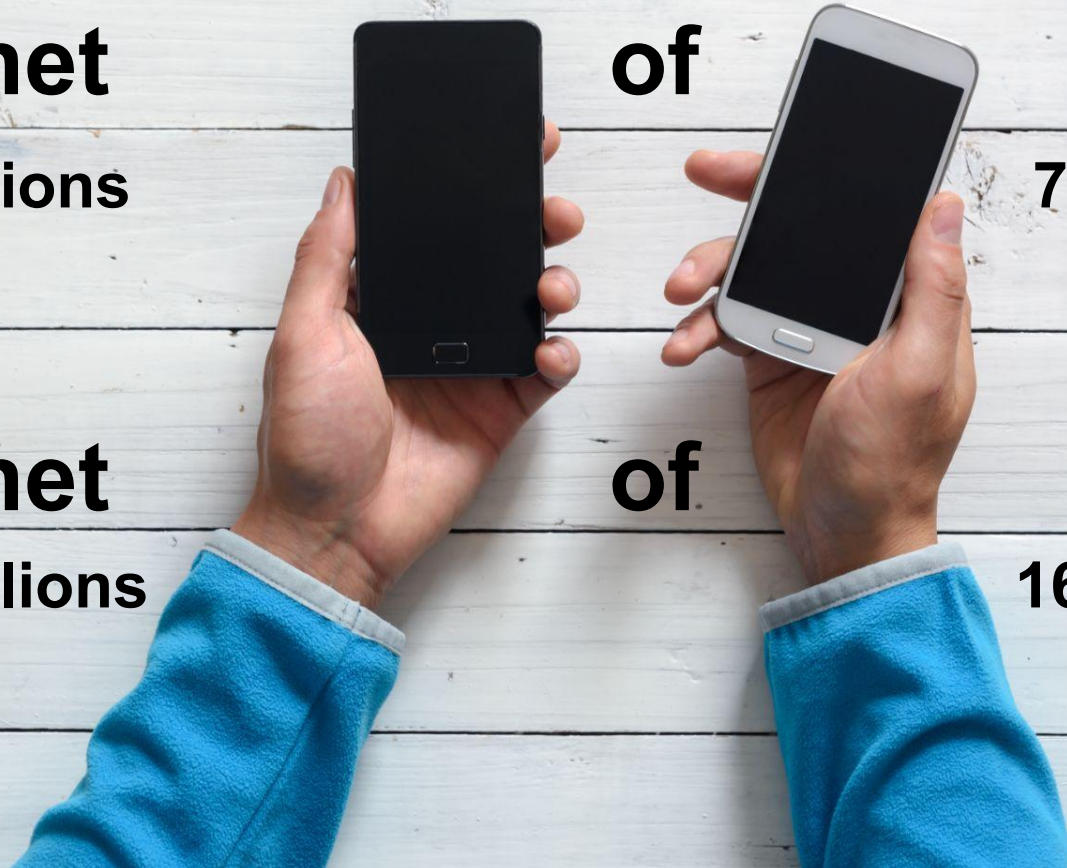

# IoT in practice: Smart Metering

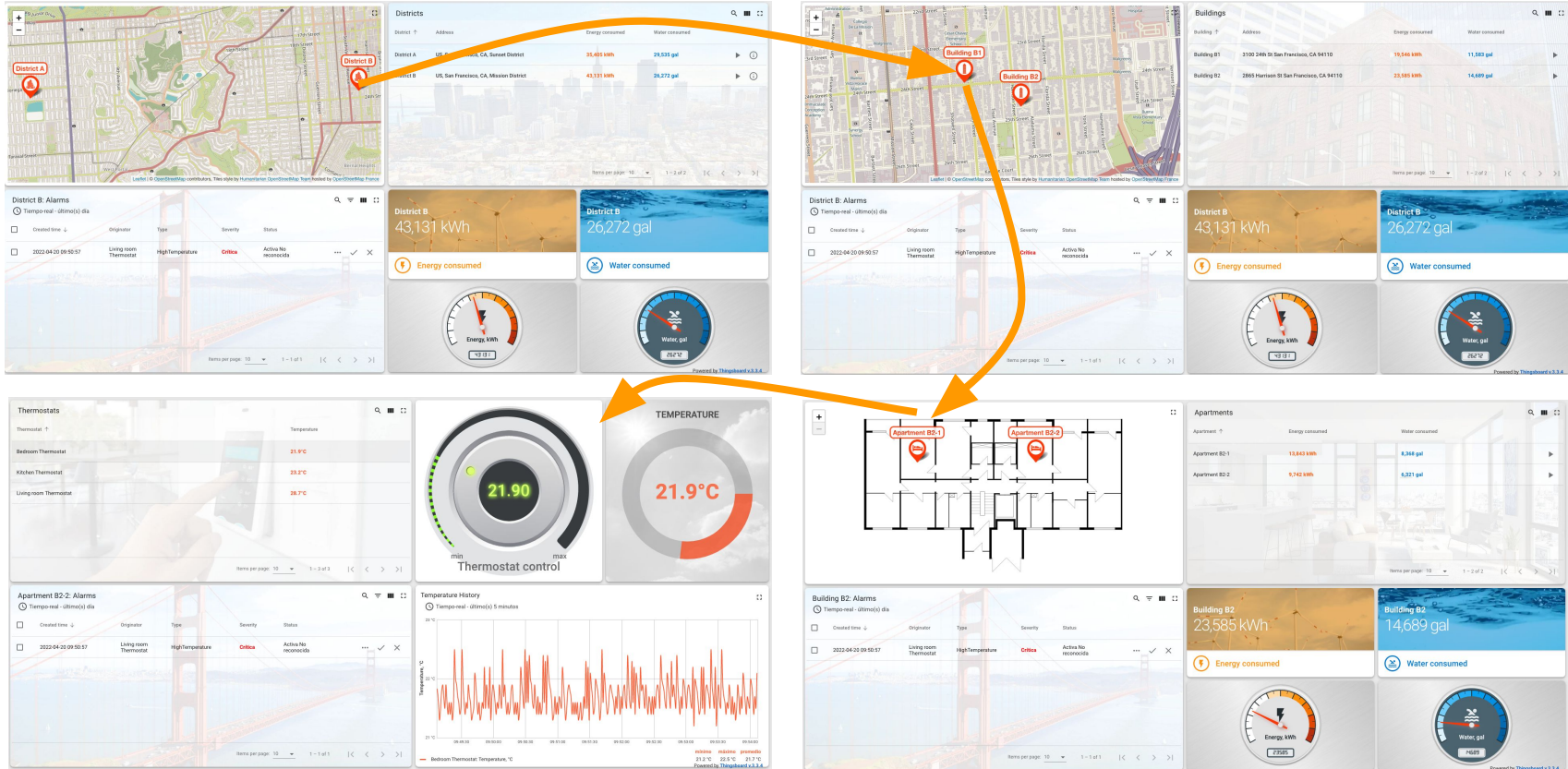

# IoT in practice: Smart Fleet

### Bus locations

### Buses

Name	Label	Status	Speed, MPH	Fuel level, %
Bus A	7BJF622	On route	30	77
Bus B	6VCF878	On route	47	57

1 - 4 of 4

### Alarms

Tempo-real - último(s) día

Start time	Originator	Type	Severity	Status
2022-04-20 10:08:15	Bus B	Out Of Route	Critical	Active N reconoc

1 - 1 of 1

Powered by Thingsboard v 3.3.4

### Route history

Historico - último(s) 5 minutos

Apr 20, 2022, 10:04:47 AM

### Bus A: Info

Label	Status	Speed	Fuel level
7BJF622	On route	22 MPH	30%

### Fuel level history

Tempo-real - último(s) minutos

Time	Fuel Level (%)
10:09:30	100
10:09:40	95
10:09:50	85
10:10:00	75
10:10:10	65
10:10:20	25

promedio 27 MPH

### Route area

### Bus A: Alarms

Tempo-real - último(s) día

No se encontraron alarmas

0 of 0

Powered by Thingsboard v 3.3.4

# IoT in practice: Smart Farm

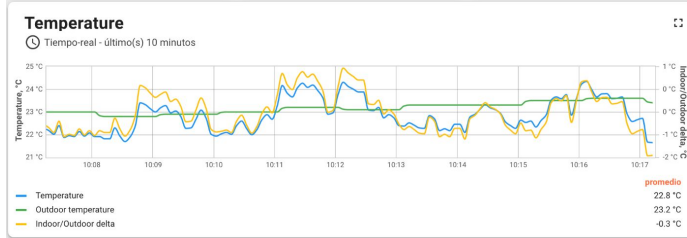
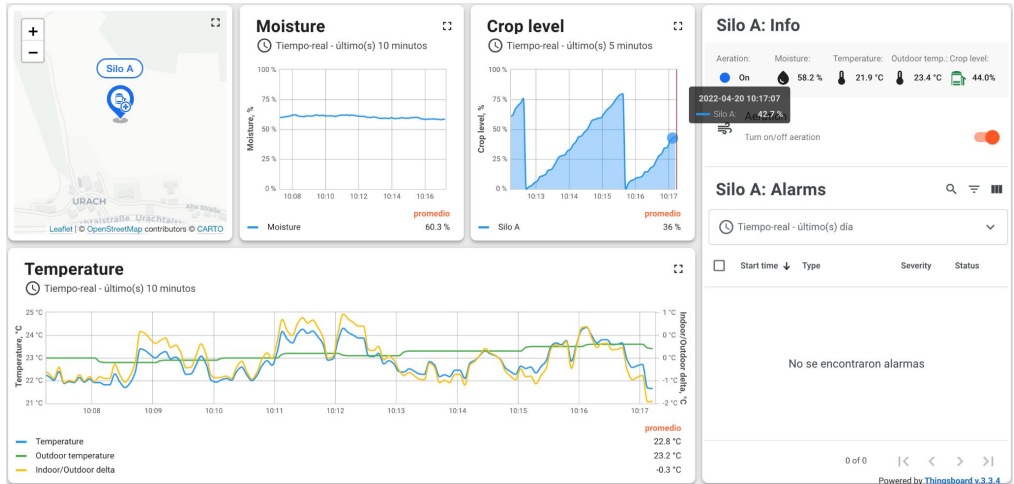
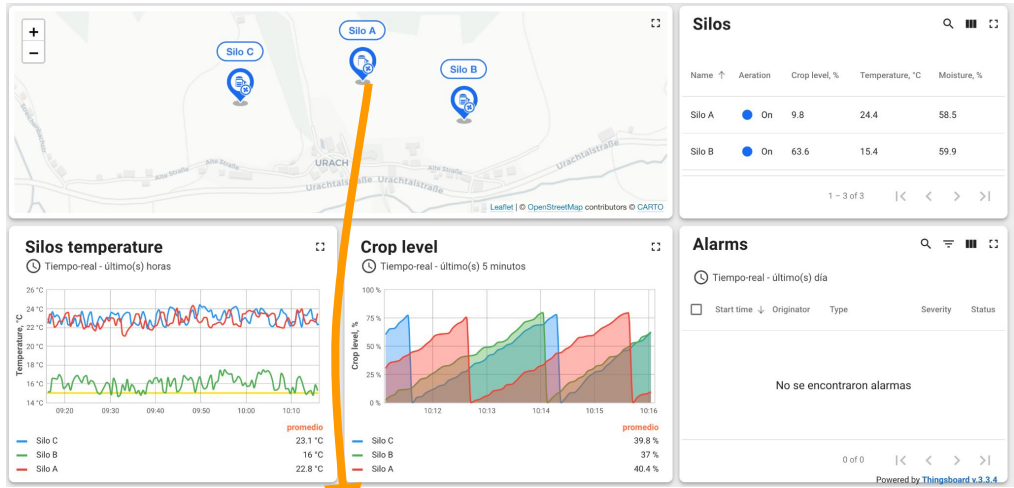

# IoT in practice: Smart Office

**HVAC switch**

**HVAC Control**

24.7

**Devices**

Name	Type
Energy meter	Energy Meter
HVAC	HVAC
Smart sensor	Smart Sensor
Water meter	Water Meter

**Temperature and Power History**

minimo	maximo	promedio
21.7 °C	27.7 °C	24.3 °C
2043 W	4946 W	3568 W

**Alarms**

Created time | Originator | Type | Severity | Details | Status

No se encontraron alarmas

**Floor plan**

**Temperature and Humidity**

Tempo-real - último(s) 2 horas

minimo	maximo	promedio
21.7 °C	27.7 °C	24.2 °C
31.4 %	57.8 %	44.7 %

TEMPERATURE: 23.7°C

HUMIDITY: 36.8%

**CO2**

724ppm

**TVOC**

0.600ppm

**Air Quality**

Tempo-real - último(s) 2 horas

minimo	maximo	promedio
527 ppm	1806 ppm	1148 ppm
0.3 ppm	0.6 ppm	0.387 ppm

**Contact Info**

**Office**

Address: 246 Bowery New York NY 10012 United States

Phone: +1112223334

Email: support@office-center.com

**Smart sensor: Alarms**

Created time | Type | Severity | Status

No se encontraron alarmas

**Occupancy History**

Tempo-real - último(s) horas

**HVAC switch**

**HVAC control**

24.7

**State History**

Tempo-real - último(s) 30 minutos

ON

TARGET TEMPERATURE: 24.7 °C

AIR FLOW: 264.9 cfm

**Target Temperature History**

Tempo-real - último(s) 30 minutos

minimo	maximo	promedio
24.7 °C	24.7 °C	24.7 °C

**State**

ON

TARGET TEMPERATURE: 24.7 °C

AIR FLOW: 264.9 cfm

**Energy consumption**

Tempo-real - último(s) 2 horas

Total: 724.60 kWh

Energy consumed per minute

**Current (Amperage) and Power**

Tempo-real - último(s) 30 minutos

minimo	maximo	promedio
14.4667 A	17.2833 A	15.8538 A
2043 W	4946 W	3444 W

POWER: 3008W

CURRENT: 14.20A

**Contact Info**

**Office**

Address: 246 Bowery New York NY 10012 United States

Phone: +1112223334

Email: support@office-center.com

**HVAC: Alarms**

Created time | Type | Severity | Status

No se encontraron alarmas

**Air Flow History**

Tempo-real - último(s) 30 dias

minimo	maximo	promedio
223.6 cfm	326.7 cfm	275.6 cfm

**Energy meter: Alarms**

Created time | Type | Severity | Status

No se encontraron alarmas

**Voltage and Frequency**

Tempo-real - último(s) 30 minutos

minimo	maximo	promedio
218.33 V	246.08 V	231.91 V
55.58 Hz	61.52 Hz	58.66 Hz

VOLTAGE: 222.10V

FREQUENCY: 61.20Hz

# IoT in practice: Smart Market

**Supermarkets** 9 Critical 4 Major

State filter

Normal
  Major
  Critical

**Supermarkets**

Name	Address	State
Supermarket S2	506 Clement St, San Francisco, CA 94118, United States	Critical
Supermarket S1	2675 Geary Blvd, San Francisco, CA 94118, United States	Critical
Supermarket S3	1165 Powell St, San Francisco, CA 94108, United States	Critical

1 - 3 of 3

**Alarms**

Tiempo-real - último(s) 7 días

Start time	Originator	Type	Severity	Status
2022-04-20 10:28:43	Chiller 65644	High Temperature Alarm	Mayor	Activa No reconocida
2022-04-20 10:24:43	Smoke Sensor 4	Low Battery	Mayor	Activa No reconocida
2022-04-20 10:24:03	Smart Bin 2	Bin is full	Mayor	Activa No reconocida
2022-04-20 10:21:03	Chiller 378876	High Temperature	Critical	Activa No reconocida

**Supermarket S1** 10 Critical 3 Major

7.4°C

3.8°C

**Filter**

Smart Shelf
  Chiller
  Freezer
  Smart Bin
  Door Sensor
  Motion Sensor

**State filter**

Normal
  Major
  Critical
  Disconnected

**Devices**

Name	Type	Label	State
Smart Shelf 457321	Smart Shelf	Vegetables	Normal
Smart Shelf 557322	Smart Shelf	Fruits	Normal
Chiller 3	Chiller	Milk	Normal

1 - 5 of 23

**Alarms**

Tiempo-real - último(s) 7 días

Start time	Originator	Type	Severity	Status
2022-04-20 10:29:03	Freezer 1	High Temperature Alarm	Mayor	Activa No reconocida
2022-04-20 10:24:43	Smoke Sensor 4	Low Battery	Mayor	Activa No reconocida
2022-04-20 10:24:03	Smart Bin 2	Bin is full	Mayor	Activa No reconocida

**Supermarket S1** 10 Critical 3 Major

6.5°C

3.1°C

**Filter**

Smart Shelf
  Chiller
  Freezer
  Smart Bin
  Door Sensor
  Motion Sensor

**State filter**

Normal
  Major
  Critical
  Disconnected

**Milk Chiller 3** Settings

Type: Chiller Label: Milk State: Normal

Temperature (6.5°C)

Tiempo-real - último(s) horas

Temperature, °C

25°C  
20°C  
15°C  
10°C  
5°C

09:40 09:50 10:00 10:10 10:20 10:30

**Milk: Alarms**

Tiempo-real - último(s) 7 días

Start time	Originator	Type	Severity	Status
No se encontraron alarmas				



# Agenda

## The 5 Keys of understand IoT

- Why IoT is important
- What is IoT and what is not
- Who uses IoT and how
- When can IoT be a solution
- Where can IoT be deployed

[Break]

Case study analysis and discussion

Live demo of an IoT application



# Agenda

The 5 Keys of understand IoT

- **Why IoT is important**
- What is IoT and what is not
- Who uses IoT and how
- When can IoT be a solution
- Where can IoT be deployed

[Break]

Case study analysis and discussion

Live demo of an IoT application



# IoT is an Opportunity



INTERNET OF THINGS

**TAKE THINGS FURTHER**

IoT is  
Everywhere



INTERNET OF THINGS

**RAFA NADAL & IOT**

# Internet of Things (IoT)

Just 2 words (actually three...) but IoT to be said.

Google Results: 5.270.000.000

Google News: 862.000.000

Google Videos: 431.000.000

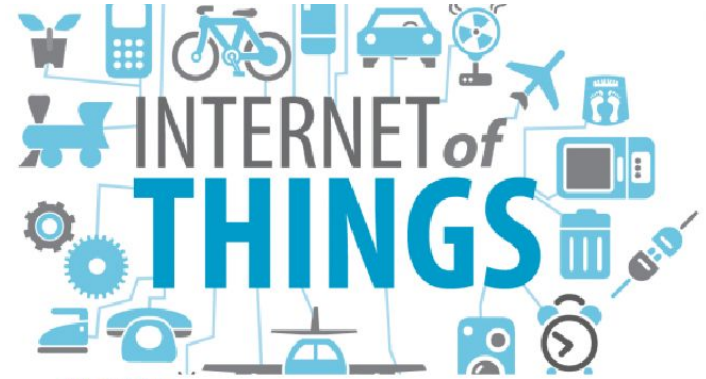

Google Trends:

**IoT vs. Data Science**

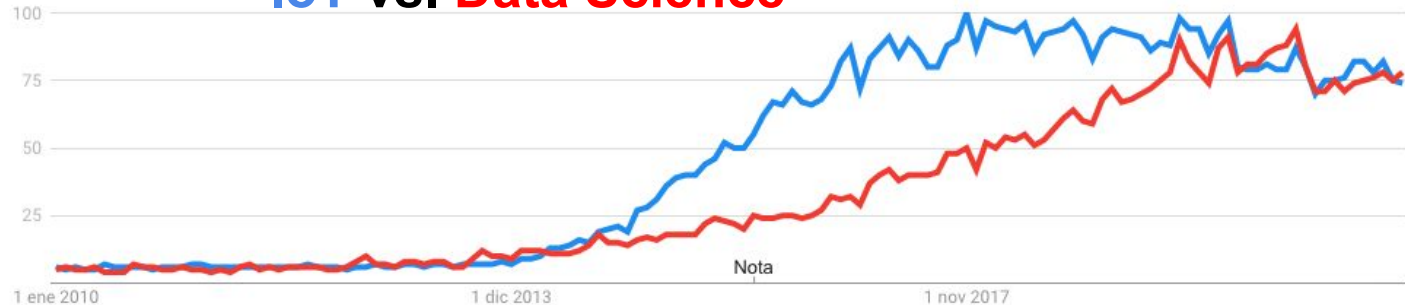

# Industrial Revolutions

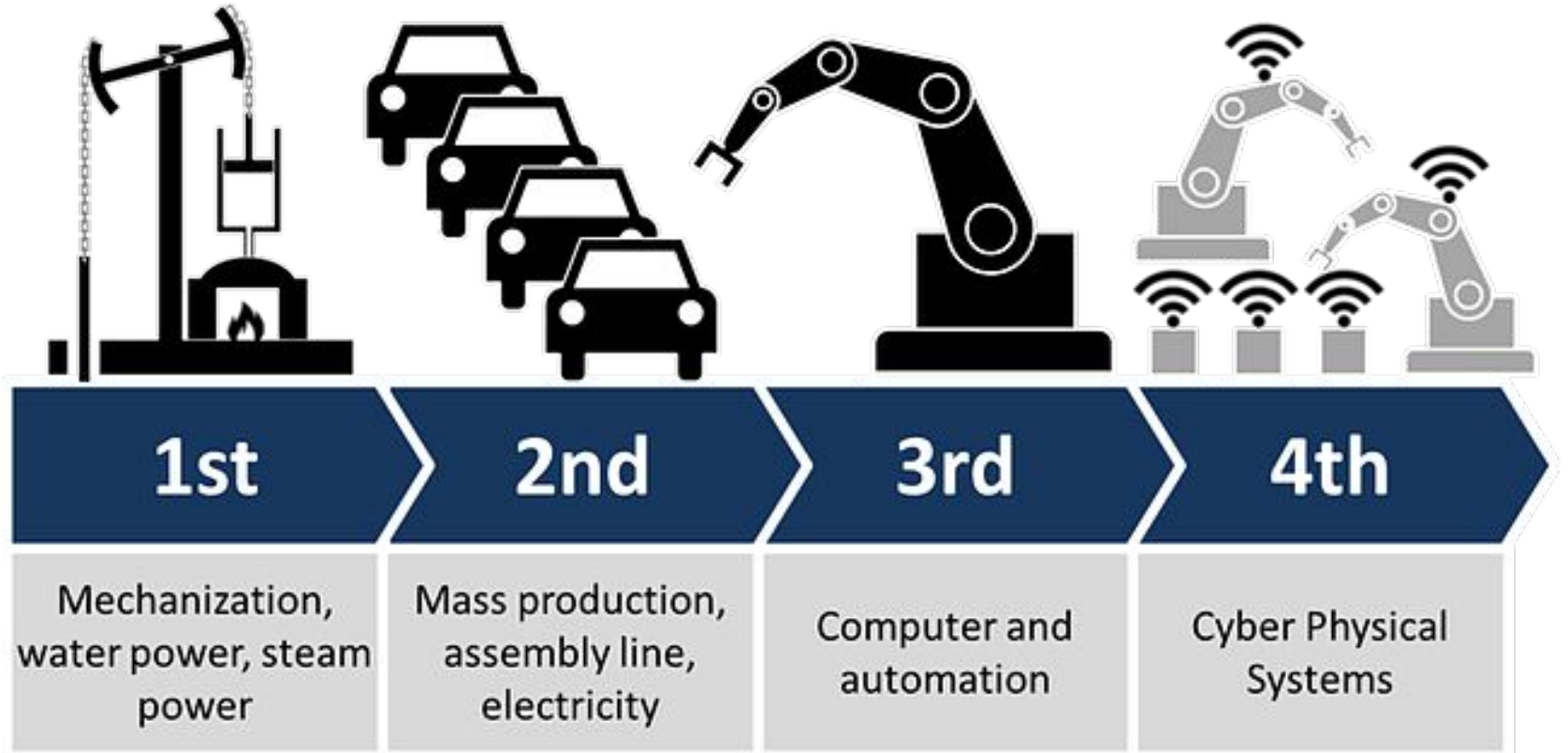

# IoT & Cyber-physical Systems



# Digital Transformation

**Adoption** of digital technologies to processes, products, and assets to **improve** efficiency, enhance customer value, manage risk, and uncover new opportunities.

Requires to convert physical systems into digital ones, typically resulting in **cyber-physical systems** (CPS) that operate in our real world (time / space)

The **Internet of Things** (IoT) can be considered a subset of CPS made up of ordinary objects that integrate capabilities to interact with the physical world and interconnect to Internet





# IoT Stories

# Smart Building



# Internet of Wine



# Industry 4.0



# Retail Experience



# Agenda

## The 5 Keys of understand IoT

- Why IoT is important
- **What is IoT and what is not**
- Who uses IoT and how
- When can IoT be a solution
- Where can IoT be deployed

[Break]

Case study analysis and discussion

Live demo of an IoT application



slido



**¿Cómo ordenarías  
estas definiciones  
según tu visión?**

① Start presenting to display the poll results on this slide.

# Dictionaries' definitions

“The interconnection via the Internet of computing devices embedded in everyday objects, enabling them to send and receive data” [Oxford]

“Objects with computing devices in them that are able to connect to each other and exchange data using the Internet” [Cambridge]

“A system of devices with the ability to transfer data over a network without requiring human interaction” [Wikipedia]

“A network of objects that are fitted with microchips and connected to the internet, enabling them to interact with each other and to be controlled remotely” [Collins]



# Professionals' definitions

“A global infrastructure for the information society, enabling advanced services by interconnecting (physical and virtual) things based on existing and evolving interoperable information and communication technologies.” [ITU]

“A trend where a large number of embedded devices employ communication services offered by the Internet protocols. Many of these devices are not directly operated by humans.” [Internet AB]

“An extension of network connectivity and computing capability to objects, devices, sensors, and items not ordinarily considered computers.” [Internet Soc.]

“A network of items - each embedded with sensors - which are connected to the Internet.” [IEEE]

# Vendors' definitions

“The IoT links objects to the Internet, enabling data and insights never available before.” [Cisco]

“Network of physical objects accessed through the internet. These objects contain embedded technology to interact with internal states or the external environment. In other words, when an object can sense and communicate, it changes how and where decisions are made, and who makes them.” [IBM]

“Network of physical objects - “things” - that are embedded with sensors, software, and other technologies for the purpose of connecting and exchanging data with other devices and systems over the internet.” [Oracle]

# Analysts' definitions

“The Internet of Things (IoT) is the network of physical objects that contain embedded technology to communicate and sense or interact with their internal states or the external environment.” [Gartner]

“A network of uniquely identifiable end points (or things) that communicate bi-directionally without human interaction using IP connectivity.” [IDC]

“Sensors and actuators embedded in physical objects linked through wired and wireless networks, often using the same Internet Protocol (IP) that connects the Internet.” [McKinsey]

“Connection of devices to the internet using embedded software and sensors to communicate, collect and exchange data with one another” [EY]

# Governments' definitions

“Things such as devices or sensors – other than computers, smartphones, or tablets – that connect, communicate or transmit information with or between each other through the Internet.” [Federal Trade Commission (FTC)]

“The Internet of Things (IoT) enables large numbers of previously unconnected devices to communicate and share data with one another.” [Ofcom]

“A distributed network connecting physical objects that are capable of sensing or acting on their environment and able to communicate with each other, other machines or computers. The data can be collected and analysed in order to reveal insights and suggest actions that will produce cost savings, increase efficiency or improve products and services.” [European Parliament]

# Bankers' definitions

“The Internet of Things is the next revolution in computing. By connecting billions of everyday things to the Web, the IoT will collect enormous volumes of data that could reshape almost every aspect of our lives.” [Morgan Stanley]

“The Internet of Things (IoT) is emerging as the next technology mega-trend, with repercussions across the business spectrum. By connecting to the Internet billions of everyday devices – ranging from fitness bracelets to industrial equipment – the IoT merges the physical and online worlds, opening up a host of new opportunities and challenges for companies, governments and consumers.” [Goldman Sachs]

# Machine to Machine (M2M)



# Machine to machine (M2M)

Direct communication (point-to-point connection) between two devices (in general, terminal and client roles) using any communications channel, including wired and wireless, without any human intervention.

Sensor telemetry is one of the original uses of M2M communication. For decades, businesses have used M2M to remotely monitor factors like temperature, energy consumption, moisture, pressure and more through sensors.

ATMs offer another great example of M2M technology: ATM's internal computer is constantly communicating with a host processor that routes transactions to the appropriate banks and accounts. The banks then send back approval codes through the host processor, allowing transactions to be completed.

# M2M Devices & Use Cases

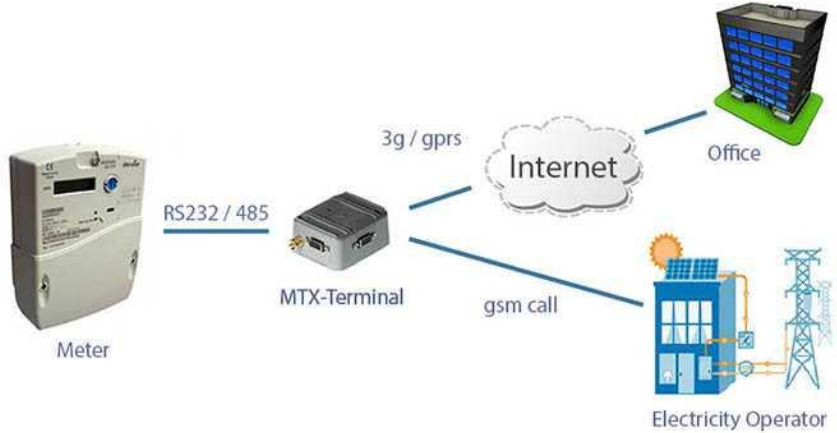



# M2M is not IoT

M2M can be considered a forerunner of IoT

M2M communication model is point-to-point, while IoT is network-based (Internet)

M2M data is usually directed towards performing a single task strongly coupled with the device application. Instead, IoT collects data that is used for different applications.

M2M communications are strictly device-based (i.e., between devices). IoT has a broader circle of possible communication subjects. Apart from devices, it can connect humans with machines, a device and a gateway, a gateway and the data system, as well as two data systems.

# Wireless Sensor Networks (WSN)

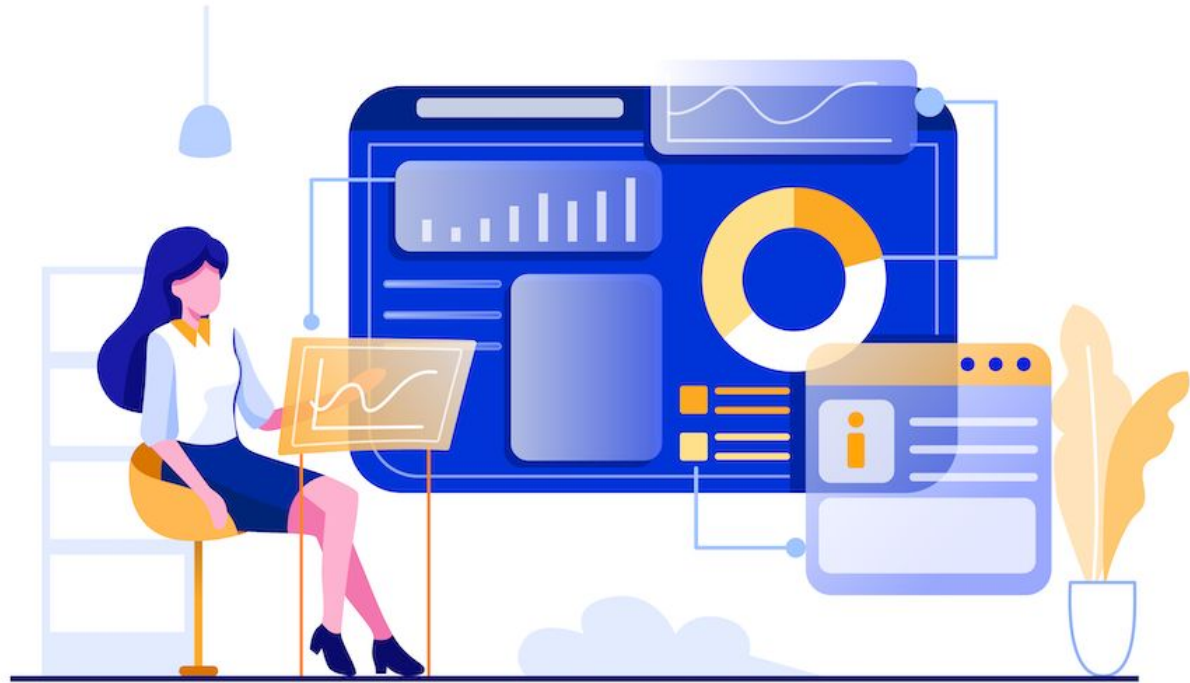

# Wireless Sensor Networks (WSN)

Group of spatially dispersed and dedicated sensors for monitoring and recording the physical conditions of the environment and organizing the collected data at a central location. WSNs measure environmental conditions like temperature, sound, pollution levels, humidity, wind, etc.

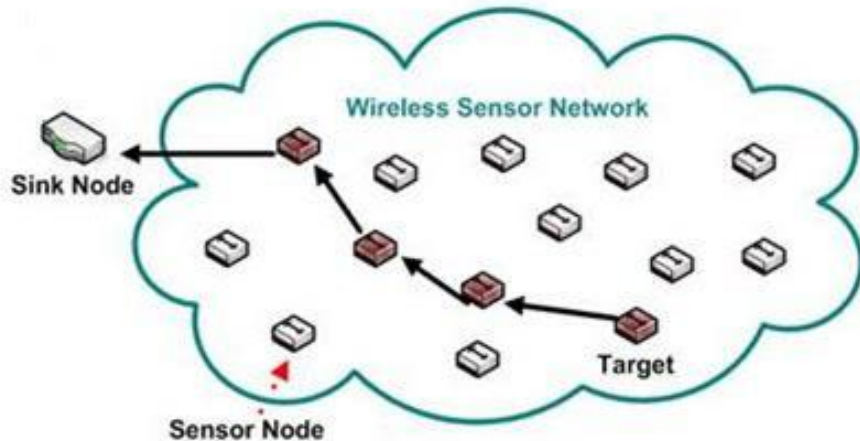

# WSN is not IoT

WSN is used mainly for coordinated collection of data. IoT goes beyond this, in a way, where smartness can be added to the objects so that they can do the work of actuation to achieve a certain goal without human intervention.

WSN uses only wireless communications. IoT can rely on both wired and wireless.

WSN uses a network-based communication model, but not necessarily compatible with Internet. IoT assumes nodes can be connected to the Internet.

WSN assumes small, low-cost and similar nodes. IoT considers any type of node, from small ones to vehicles, or even bigger.

# Historical Background





# Historical Background (World War II)

Radio frequency identification (RFID) can be seen as a crucial technology for IoT.

Back to World War II, radars were used to warn of approaching enemy planes while they were still miles away, but there was no way to identify which planes belonged to the enemy and which were own pilots returning from a mission.

Germans discovered that if pilots *rolled their planes* as they returned to base, it would change the radio signal reflected back to radar systems. This crude alerted the radar crew on the ground that these were German planes. Essentially, this was the first passive RFID system.

British developed the first active “RFID” system. When a British plane received a radar signal, it would broadcast a signal back that identified the aircraft as friendly.

# Historical Background (1950 - 1960)

US, Europe and Japan explored how RF can be used to detect the presence of objects remotely.

Companies began commercializing *anti-theft systems* that used radio waves to determine whether an item had been paid for or not (by detecting the presence of a physical label)

Early electronic article surveillance tags did not identify the item nor its state (paid or not) and required to be removed after the item was purchased





# Historical Background (1970 - 1980)

Los Alamos National Laboratory developed a system for tracking nuclear materials.

The concept used an **active** transponder in a truck and readers (with antennas) at the gates of secure facilities. The gate antenna would *wake up* the transponder in the truck, which would respond with an identification (ID) stored inside the transponder.

This system was later used to develop automated toll payment systems. These systems became widely used on roads, bridges and tunnels around the world.



# RFID Working Principle

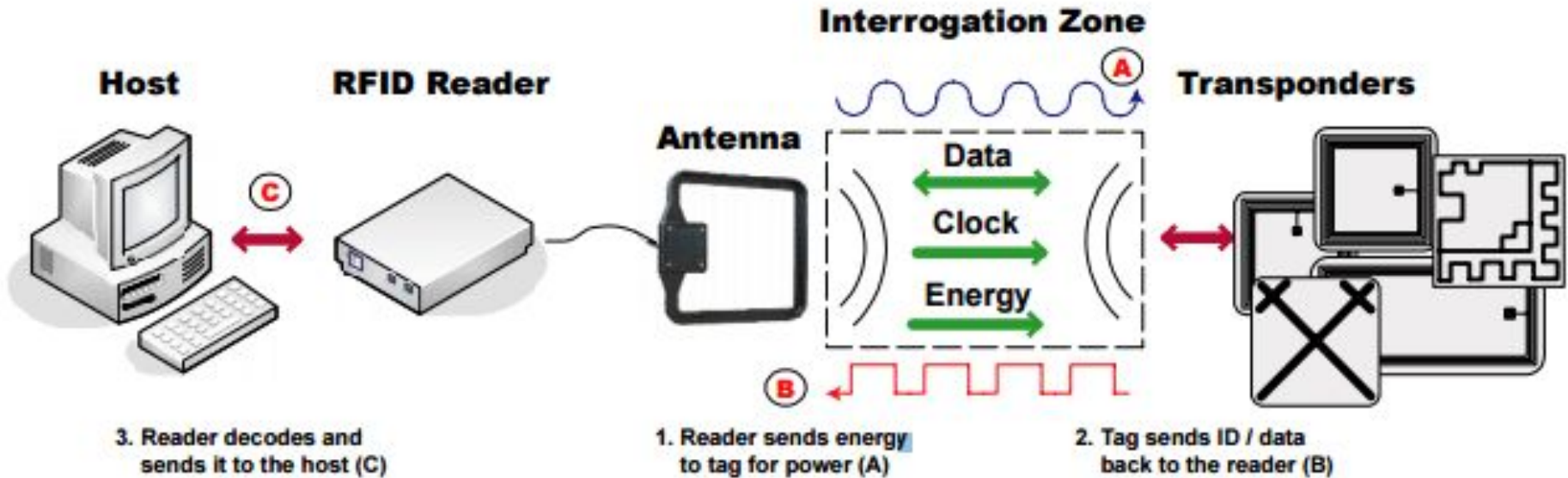
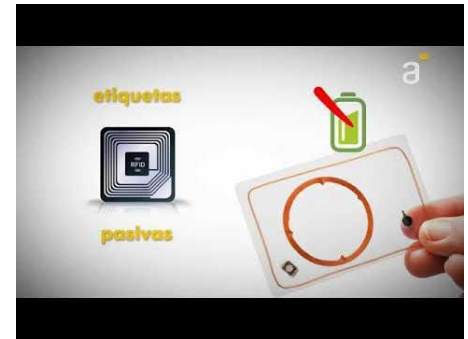

# Historical Background (1970 - 1980)

A **passive** RFID tag that used UHF (~GHz) was developed to track cows and their doses of hormones and medicines to ensure that each cow wasn't given two doses accidentally.

The device drew energy from the reader and simply reflected back a modulated signal to the reader (backscatter)

Later, a low frequency (125 kHz) system (smaller transponders but shorter distance) was developed, which encapsulated in glass could be injected under a cow's skin.

Low frequency transponders were also put in cards and used to control access to buildings.



# Historical Background (1990 - 2000)

UHF RFID got a boost in late 1990, when the [Auto-ID Center](#) at MIT was created.

Low-cost RFID tags to track products through the supply chain: a “serial number” on the tag to keep the price down. Simple microchip with little information less expensive to produce than a more complex chip with more memory.

Data associated with this “serial number” on the tag stored in a database accessible over the Internet. Tags were not any more a mobile database carrying information about the product or container as they traveled.

The Auto-ID Center used the term "Internet of Things" in ~2000 and developed the [Electronic Product Code](#) scheme designed to identify each item manufactured, as opposed to just the manufacturer and class of products, as bar codes do today.

# Electronic Product Code

A 96-bit EPC has 4 distinct parts:

**Header (8):** type of EPC.

**Manager (28):** 268.435.455 different product manufacturers

**Class (24):** 16.777.215 different types of object.

**Serial Number (36):** 68.719.476.735 potential unique identification numbers per object.

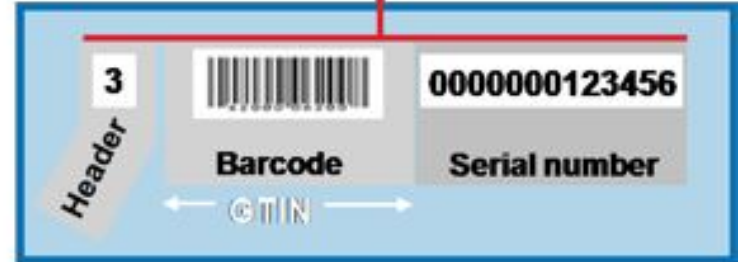
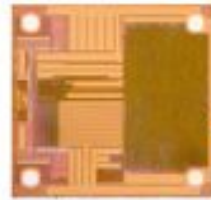

**Each object has an unique ID**

# Back to IoT Definition

An IoT is a network that connects uniquely identifiable “Things” to the Internet.

These “Things” have sensing, actuation and potential programmability capabilities.

Through the exploitation of unique identification information about the “Thing” can be collected and its state changed from anywhere, anytime, by anything.“

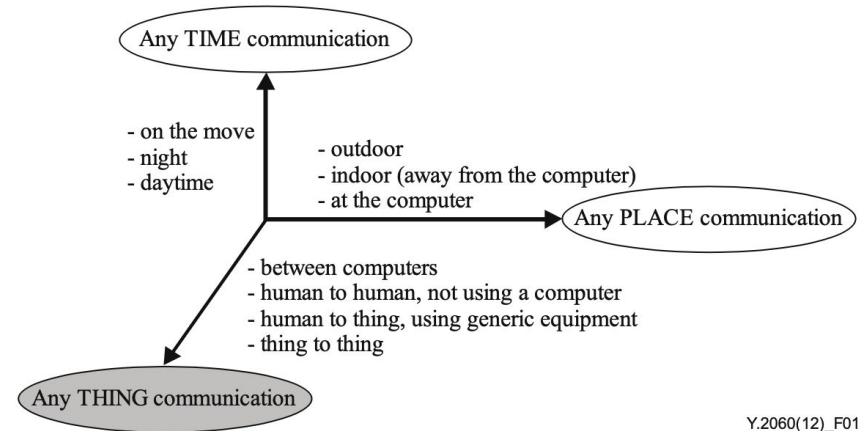

IoT adds the "Any THING communication" dimension to ICT, which already provide "any TIME" and "any PLACE" communication.

# Agenda

## The 5 Keys of understand IoT

- Why IoT is important
- What is IoT and what is not
- **Who uses IoT and how**
- When can IoT be a solution
- Where can IoT be deployed

[Break]

Case study analysis and discussion

Live demo of an IoT application



# IoT Top Applications



**Desafío:** identificar cosas “inteligentes en cada aplicación”

Insights that empower you to understand IoT markets

## Top 10 IoT Application areas 2020

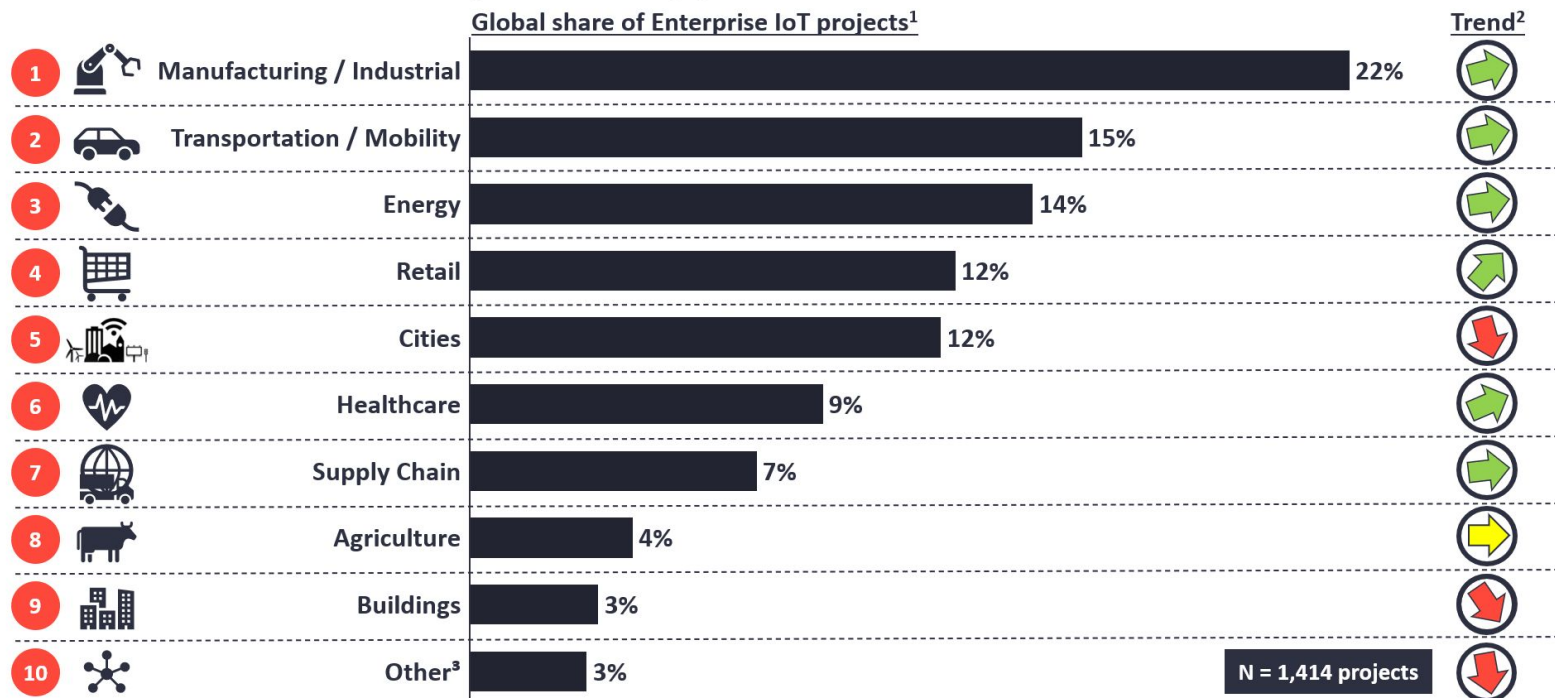

**Note:** 1. Based on 1,414 publicly known IoT projects (not including consumer IoT projects eg smart home, wearables, etc.) 2. Trend based on relative comparison with % of projects in the 2018 IoT Analytics IoT project list e.g., a downward arrow means the relative share of all projects has declined, not the overall number of projects. 3. Other includes IoT projects from Enterprise & Finance sectors. **Source:** IoT Analytics Research - July 2020



# (1) IoT @ Manufacturing / Industrial

Industrial IoT application area covers a wide range of connected “things” projects both inside and outside the factory.

**Inside:** many IoT-based factory automation and control projects include holistic smart factory solutions with numerous elements such as production floor monitoring, wearables and Augmented Reality on the shop-floor, remote PLC control, or automated quality control systems.

**Outside:** include remote control of connected machinery, equipment monitoring, or management and control of entire remote industrial operations such as oil rigs. Many of the case studies mention “reducing operational downtime and cost saving” as the key drivers for OEMs to introduce industrial IoT solutions.

# Example: Bosch Injector Manufacturing

The information is embedded in the component and is capable of managing the production process, for example by ordering missing components or setting up the individual production parameters.

Simultaneously, customers are kept informed of the current state of production.



# Example: Howden Mixed Reality solutions

Howden, a Scottish manufacturer of air and gas handling solutions, developed a scalable mixed reality solutions that overlay real-time IoT data from connected products with 3D Augmented Reality experiences to provide step-by-step instructions on how to solve problems with the equipment.

[More details](#)



## (2) IoT @ Transportation / Mobility

Typical applications include telematics and fleet management solutions that connect with the local operating system within the car for vehicle diagnostic/monitoring such as battery monitoring, tire pressure monitoring, driver monitoring or simply vehicle tracking.



# Example: Volvo Transport of the Future

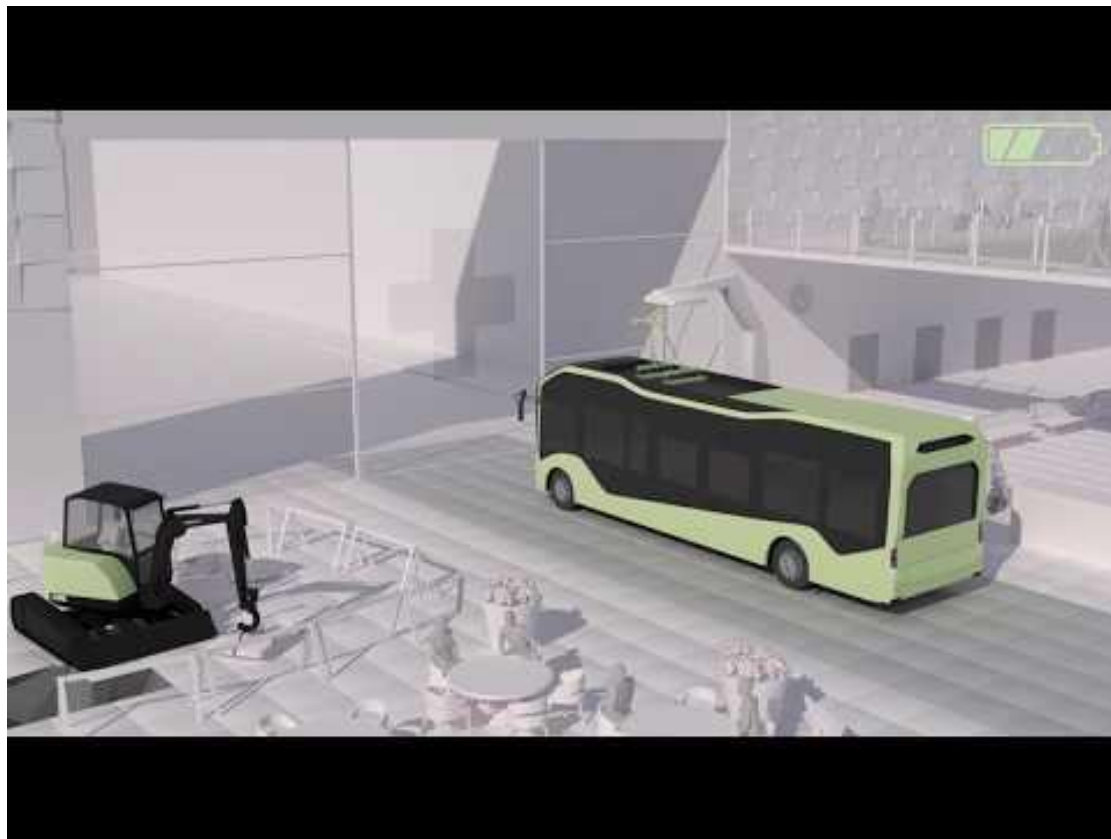

## **(3) IoT @ Energy**

IoT is revolutionizing nearly every part of the energy industry from generation to transmission to distribution and changing how energy companies and customers interact. Both solution providers and energy companies themselves understand the need for and value of connected IoT solutions in the sector.

IoT projects focus on energy distribution, grid optimization, remote asset monitoring and management, predictive maintenance and creating more transparency for better informed customers.

# Example: Enel's grid reliability solution

To improve grid reliability and reduce the occurrence of faults, Enel, an Italian multinational energy company, deployed the C3.ai Predictive Maintenance application for 5 control centers.

The application uses AI to analyze real-time network sensor data, smart meter data, asset maintenance records, and weather data to predict feeder failure.

[More details.](#)



# Example: Telefónica Smart Energy





## (4) IoT @ Retail

Retailers recognize that they can improve their cost-efficiency and in-store customer-experience through innovative IoT use cases.

Typical IoT in retail solutions include in-store digital signage, customer tracking and engagement, goods monitoring and inventory management and smart vending machines among others.



# Example: Telefónica Smart Retail



## (5) IoT @ Cities

Smart cities are growing and blossoming in all parts of the world.

Typical IoT projects in Smart Cities include connected traffic (smart parking, traffic management), utilities (smart waste, lighting), public safety (video surveillance) and environmental monitoring (air pollution).



# Example: San Nicolás de los Arroyos

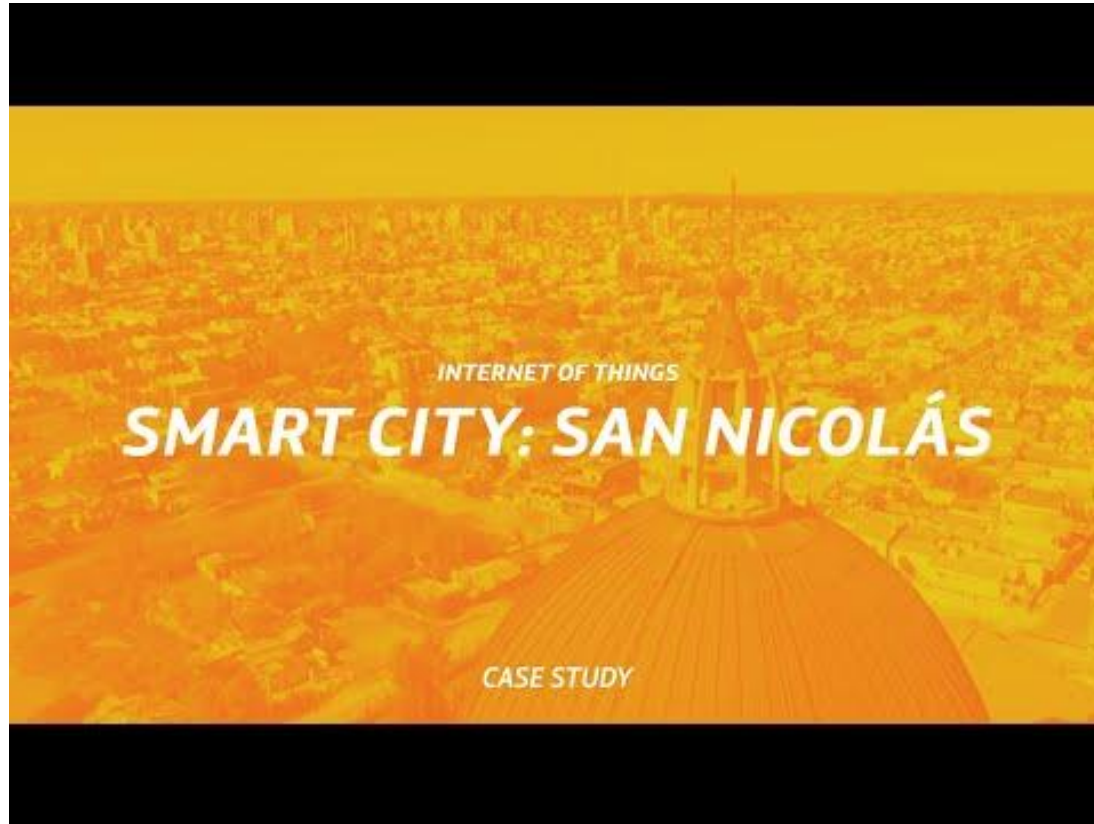

## (6) IoT @ Healthcare

Slowly proliferated itself in healthcare, but changing in light of the center of COVID-19 pandemic. Early data suggests that digital health solutions that relate to COVID-19 are surging.

Demand for specific IoT health applications such as telehealth consultations, digital diagnostics, remote monitoring, and robot assistance is increasing.



## Example: Medisanté remote patient monitoring.

Simple remote patient monitoring with continuous monitoring of assets connected to healthcare applications, including battery life and general health of devices, which allows personalized patient care anytime, anywhere and equips care teams with a near real-time view of the patient's health and activities.

[More details.](#)



## **(7) IoT @ Supply Chain**

As supply chains extend more and more to the end customers, resulting in more intricate flows of goods that are more complex to deliver, logistics providers are increasingly integrating connected digital solutions to tackle the complexity

Typical supply chain IoT projects include asset tracking, condition monitoring (e.g., cold chain, medical goods), inventory and storage management, automated guided vehicles, connected workers, among others.

## Example: Smart Label





# Example: DHL SmartSensor



# Example: Telefónica Home Delivery



## **(8) IoT @ Agriculture**

In 2050, it is estimated that a population of almost 10 billion people will need up to 70 percent more food than we do today. One way to address this challenge is through smart agriculture.

IoT sensors can help farmers make more informed decisions to achieve higher crop yield, better quality produce, and save costs by reducing the use of fertilizers and pesticides.

# Example: Plantae



# Example: Winery of the Future



## Example: Virtual Fences



## (9) IoT @ Buildings

Typical connected building projects involve facility-automation and monitoring for building systems (HVAC, lighting, elevators, smoke alarms, fire extinguishers), building utilization and security (room use, access, surveillance).



# Example: Siemens Smart Building

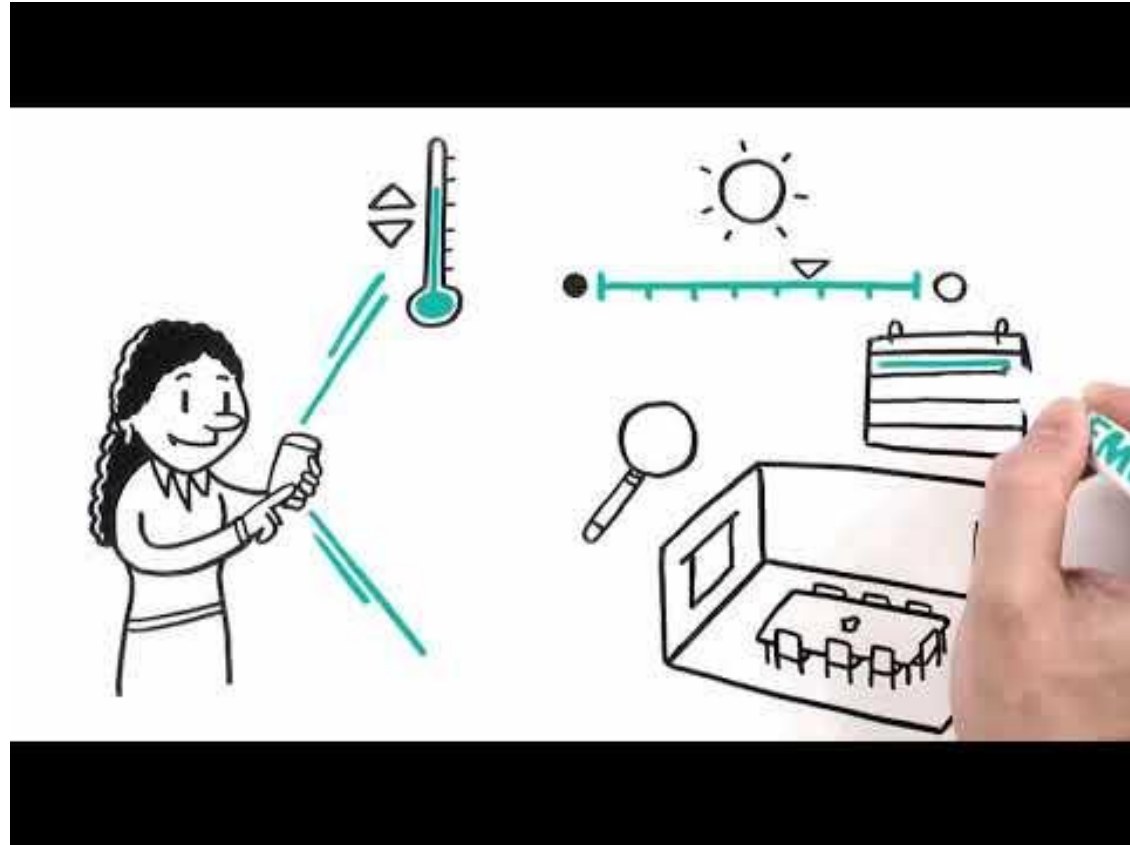



# Example: Microsoft IoT for Buildings

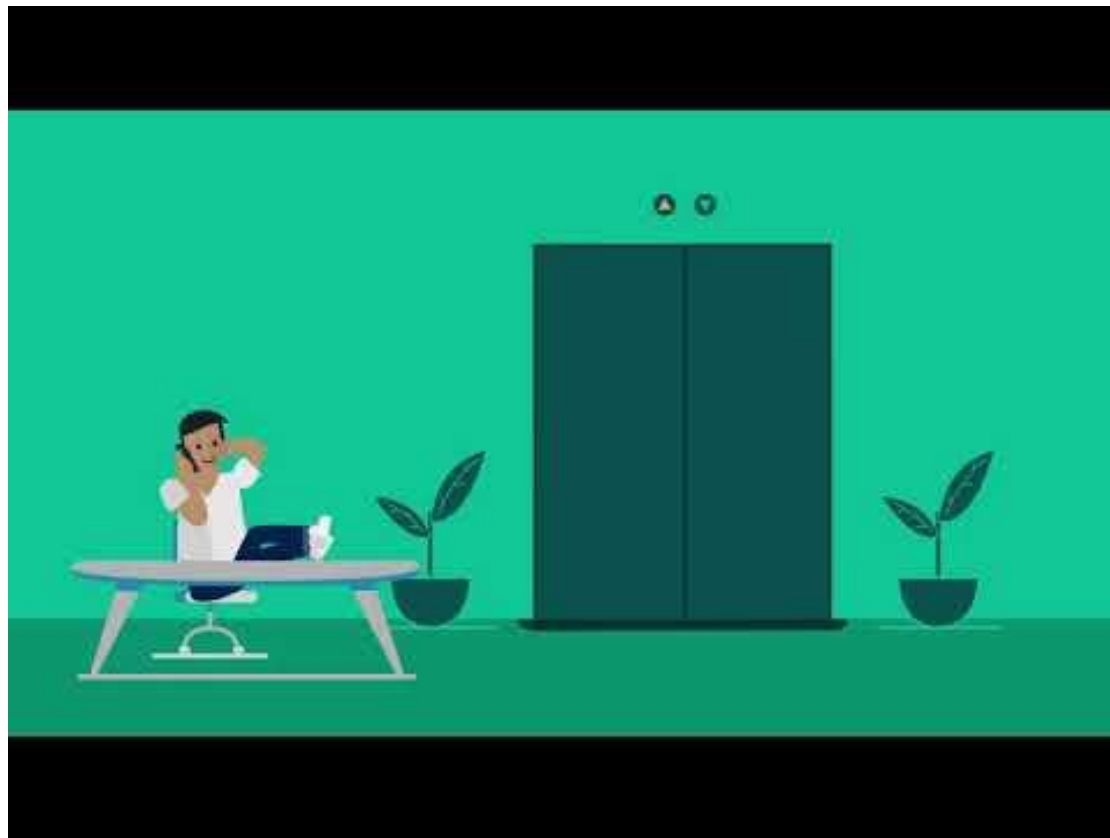

slido



**¿Qué cosas "inteligentes"  
identificamos en los casos  
anteriores?**

① Start presenting to display the poll results on this slide.

# Agenda

## The 5 Keys of understand IoT

- Why IoT is important
- What is IoT and what is not
- Who uses IoT and how
- **When can IoT be a solution**
- Where can IoT be deployed

[Break]

Case study analysis and discussion

Live demo of an IoT application



# When **interacting** with the physical world

“Things” interact with their environment: they can read from (inputs) and write to (output) the environment

Interaction is done through **transducers**: *a transducer is a device that converts energy from one form to another.* Usually a transducer converts a signal in one form of energy to a signal in another.

Transducers are often employed at the boundaries of automation, measurement, and control systems, where electrical signals are converted to and from other physical quantities (energy, force, torque, light, motion, position, etc.).

# Type of Transducers

Transducers can be categorized in two types based on the direction the information passes through.

A **sensor** is an *input device* which converts a state condition or quantity from a physical system into an information signal. States can be continuous (temperature, speed) or discrete (open/closed)

Instead, an **actuator** is an *output device* that converts an information signal into some kind of action that aims at changing some state or quantity of a physical system. Typically this is used to control some external system.

**Examples:** a microphone (input) converts sound waves into electrical signals and a loudspeaker (output) converts these electrical signals into sound waves

# Sensors



# Typical Sensors

- Temperature: air temperature or temperature of what they are immersed in. Often combined with air pressure and humidity in a single sensor.
- Buttons/Switches: indicate if they have been pressed or its position.
- Light: detect light levels and can be for specific colors, UV light, IR light, or general visible light.
- Scanners ([RFID/NFC](#), [FP](#), [BC](#)): identify surrounding objects
- Cameras: visual representation of the world by taking a photograph or streaming video to identify events (motion) or extract information (QR, text).
- Accelerometers: sense movement in multiple directions.
- Microphones: sense sound, either general sound levels or directional sound.
- Location (GPS): report location (latitude, longitude) of the device

# Sensors for IoT Applications

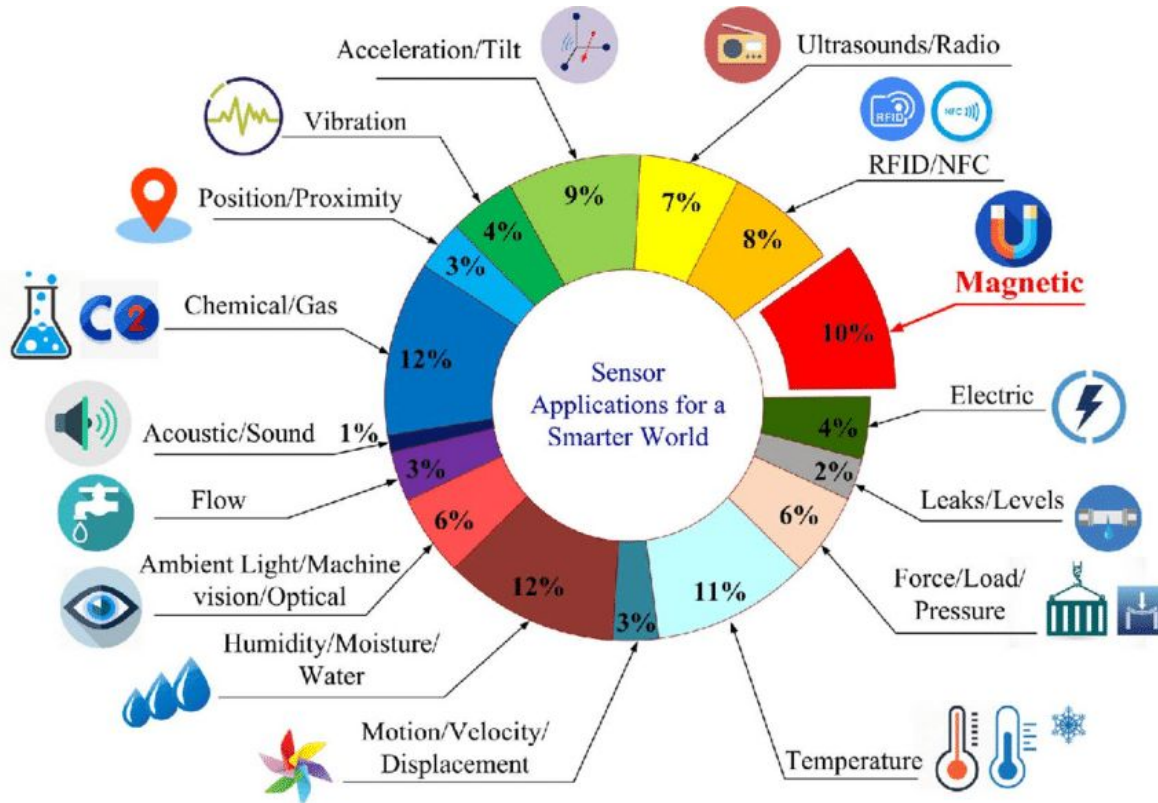

[Review IoT Commercial Products with sensors](#)



# Analogue Sensors

Produce a continuous output signal or voltage which is generally proportional to a quantity that is *changing smoothly and continuously over time*.

These signals tend to be very small in value from a few microvolts ( $\mu\text{V}$ ) to several millivolts ( $\text{mV}$ ), so some form of amplification is required. Then circuits which measure analogue signals usually have a slow response and/or low accuracy.

Physical quantities such as Temperature, Speed, Pressure, Displacement, etc. are all analogue quantities as they tend to be continuous in nature.



Temperature



Speed



Pressure



Displacement

# Analog to digital conversion

Analog sensor values need to be converted to a digital signal before they can be processed.

Most IoT devices have analog-to-digital converters (ADCs) to convert analog inputs to digital values

The voltage that comes out of the sensor is read in electrical units (typically, voltage) but by calculations inside the code ran in the IoT device be converted to physical quantities such temperature (C), distance (meter), etc

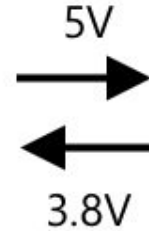
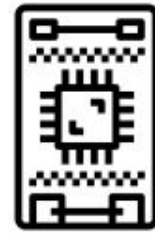

# Digital Sensors

Produce a discrete digital output signals or voltages that are a digital representation of the quantity or state being measured.

Digital sensors produce a binary output signal in the form of a logic “1” or a logic “0”, (“ON” or “OFF”). Discrete (non-continuous) values may be outputted as a single “bit”, (serial transmission) or by combining the bits to produce a single “byte” output (parallel transmission).

Analogue sensors output can be easily converted into digital ones for use in microcontroller systems by the use of analogue-to-digital converters (ADCs).

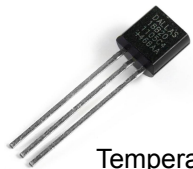

Temperature



Ambient



Accelerometer



Magnetometer

# Actuators



# Actuators

Actuators are the opposite of sensors - they convert an electrical signal from your IoT device into an interaction with the physical world such as emitting light or sound, or moving a motor.

- Analog actuators: convert a signal level (voltage) or its duty cycle ([PWM](#)) to modify some interaction: light dimmer
- Digital actuators: convert a digital signal into multiple states (LED, screen)

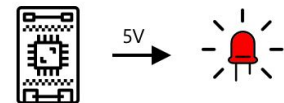
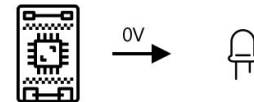
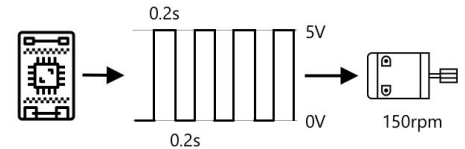
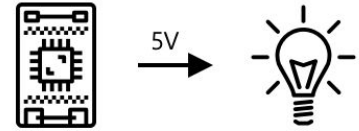
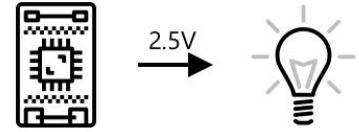

# Typical Actuators

- LED - these emit light when turned on
- Speaker - these emit sound based on the signal sent to them, from a basic buzzer to an audio speaker that can play music
- Stepper motor - these convert a signal into a defined amount of rotation, such as turning a dial 90°
- Relay - these are switches that can be turned on or off by an electrical signal. They allow a small voltage from an IoT device to turn on larger voltages.
- Screens - these are more complex actuators and show information on a multi-segment display. Screens vary from simple LED displays to high-resolution video monitors.

# When **storing** collected real-world data



Memory can be categorized as non-volatile and volatile.

Non-volatile memory (NVM) is capable of retaining data even after power is removed and generally has a lower speed than volatile memory.

Volatile memory, on the other hand, does not retain data after power is removed and has higher per-bit storage costs.

NVM is then used for storing acquired data by sensors

Most popular NVM for IoT is Flash memory because it is inexpensive, reliable, high density and does not consume too much power.

# Storage Sizing

Total amount of data depends on the data resolution (size of each sample) and the acquisition rate, and the transmission frequency

In general, it is assumed that all collected data can be transmitted every time a new transmission opportunity is available.

Typical strategies tend to some collect data before transmitting data

Too expensive (in terms of energy) to transmit data as it is acquired, hence, the acquisition rate is typically faster than the communication one

¿How would you size the memory then?



# When **processing** information near data sources

A typical IoT node is made of microcontroller which is capable of interfacing with sensors and actuators.

This microcontroller needs to temporally store collected data in memory until it is transmitted to a third party

Besides, energy is required to feed all the node's components

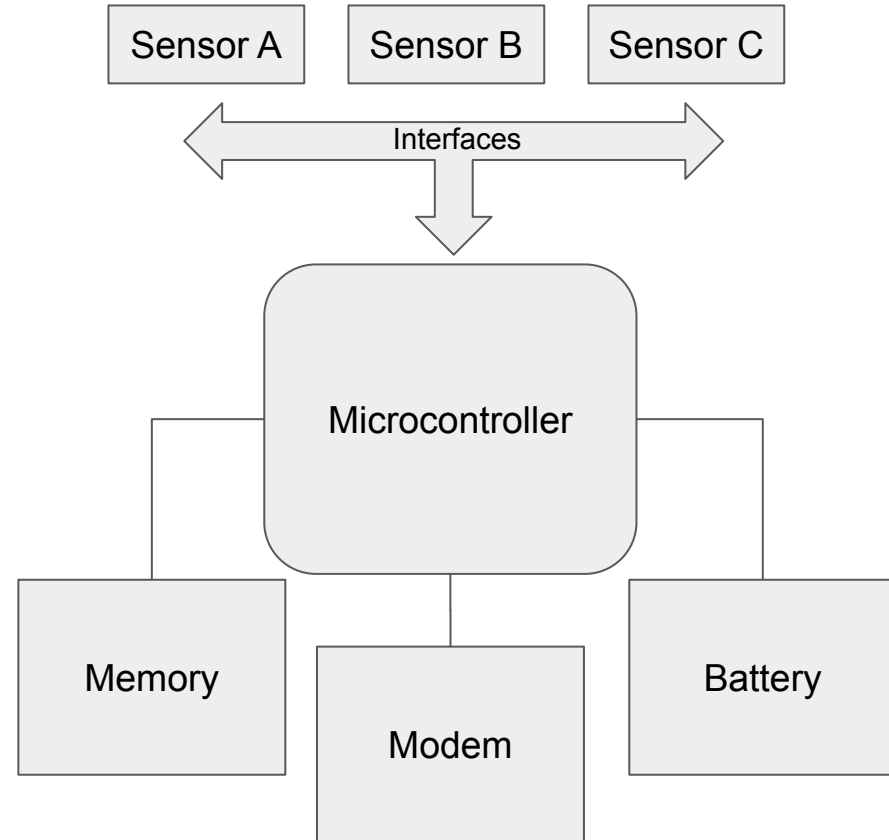

# Microprocessors vs. Microcontrollers

Microprocessors (MPU) are different than microcontrollers (MCU) in their design.

Microprocessors have only CPU inside and no in-memory support.

Microcontrollers have CPU, RAM, ROM and other peripherals which are all embedded on the same chip.

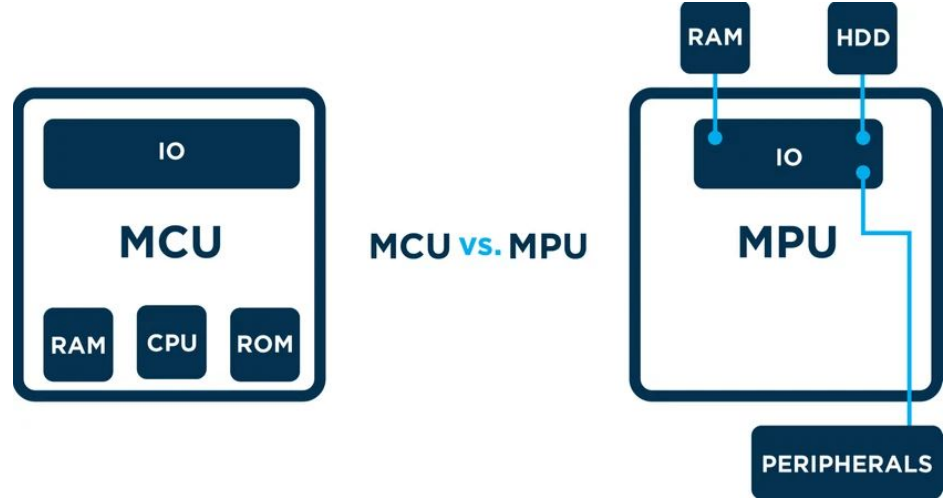

IoT devices tend to use microcontrollers or *System on Chip (SoC)* which also integrated ADC and radio communications capabilities

# IoT Microcontroller Key Features

- **Bits:** supported number of bits. Impacts the speed at which they are able to perform non-trivial computations. Typically either 8-bit or 32-bit
- **RAM:** fast-access volatile memory, which allows your MCU to quickly perform various actions. The more you have, the better, but increases the cost. From a up to fea KB (8-bit MCU) to a few MB (32-bit MCU)
- **ROM:** stores the application program in the microcontroller. Bigger the size, the more complex it becomes. Typically emulated using a Flash memory
- **Input / Output Ports:** interfaces and GPIO pins that you will use for connecting your sensors and actuators. Ranges from a few to hundreds.
- **Operating System:** from no operating system (bare metal) to Linux-based ones, which are much easier to program.

# IoT Microcontrollers: # Bits

Primary distinction between different MCUs:

- **8-bit**: mostly used in a very cost constrained. Mostly with a simple control loop, but sometimes running an RTOS. Example: Arduino
- 16-bit: not very common in IoT, typically switch between 8 and 32-bit.
- **32-bit**: normal entry point unless the application can fit on 8-bit architecture and has cost constraints. Example: Raspberry Pi, ESP32
- 64-bit: reserved for high-end systems, normally Linux or other OS. Normally you need a specific (compute intensity) reason to jump from 32-bit to 64-bit.

Besides #bits, the frequency (MHz) is also important. The larger, the faster but also more power consuming. Typically, frequencies range from 20MHz to 100MHz

# IoT Microcontrollers: OS

Bare Metal	RTOS (Real-Time Operating System)	Linux-based
Original and simplest approach	Provides guarantees for the timing of processing with input/output events	Popular open-source operating system based on UNIX, originally for personal computers
No operating system	Program runs within the operating system	Significantly more accessible and easier to program
Code talks directly to the computing components	Have the ability to suspend a task and have a high-priority task execute	Robust community of people who can help with support
Limited programming support	Quick to set up but time-consuming to debug	More difficult to get real-time performance

# Commercial Microcontrollers (SoC)

Brand	Models	CPU	RAM	+	Price	Type	Connectivity
Arduino	20+ and many clones (Spark, Intel, and so on)	ATmega, 8–64 MHz, Intel Curie, Linino	16 KB–64 MB	Largest community	~30 USD	RTOS, Linux, hobbyists	Pluggable extension boards (Wi-Fi, GPRS, BLE, Zigbee, and so on)
Raspberry Pi	A, A+, B, B+, 2, 3, Zero	ARMv6 or v7, 700 MHz -1.2 GHz	256–1 GB	Full Linux, GPU, large community	~5-35 USD	Linux, hobbyists	Ethernet, extension through USB, BLE (Pi3)
Intel	Edison	Intel Atom 500 MHz	1 GB	X86, full Linux	~50 USD	Linux, hobbyist to industrial	Wi-Fi, BLE
BeagleBoard	BeagleBone Black, X15, and so on	AM335x 1 GHz ARMv7	512 MB–2 GB	Stability, full Linux, SDK	~50 USD	Linux, hobbyist to industrial	Ethernet, extension through USB and shields
Texas Instruments	CC3200, SoC IoT, and so on	ARM 80 MHz, etc.	from 256 KB	Cost, Wi-Fi	<10 USD	RTOS, industrial	Wi-Fi, BLE, Zigbee
Marvell	88MC200, SoC IoT, and so on	ARM 200 MHz, etc.	from 256 KB	Cost, Wi-Fi, SDK	<10 USD	RTOS, industrial	Wi-Fi, BLE, Zigbee
Broadcom	WICED, and so on (also at the heart of the Raspberry Pis)	ARM 120 MHz, and so on	from 256 KB	Cost, Wi-Fi, SDK	<10 USD	RTOS, industrial	Wi-Fi, BLE, Zigbee, Thread

- [Arduino](#)
- [Raspberry](#)
  - [BCM](#)
- [ESP32](#)

# Libelium Wasp mote

- Microcontroller: [ATmega1281](#)
- Frequency: 14.74 MHz
- SRAM: 8 kB
- EEPROM: 4 kB
- FLASH: 128 kB
- SD card: 16 GB
- Weight: 20 g

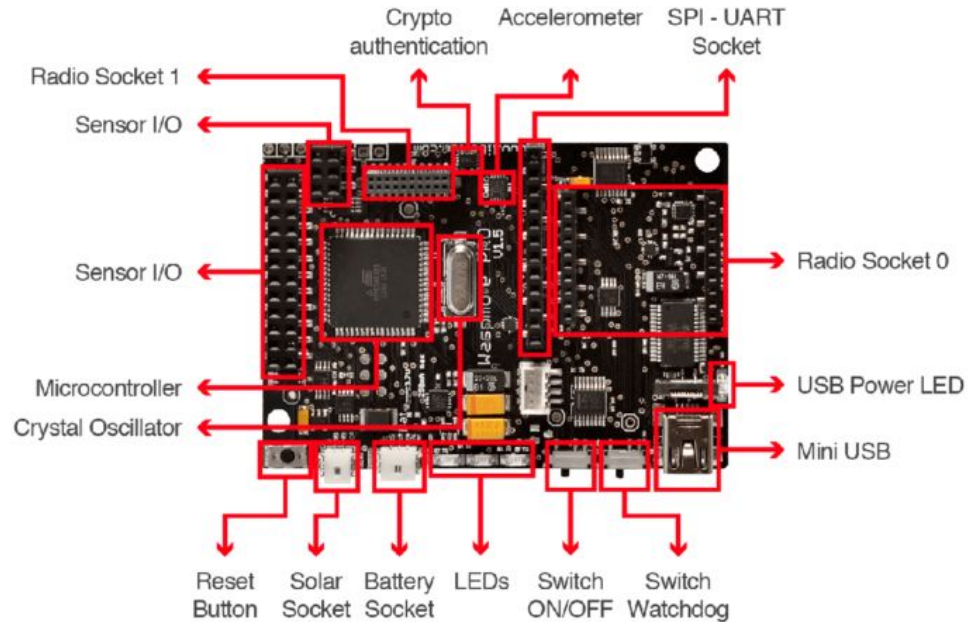

# Pycom

- [Espressif ESP32 chipset](#)
- 2 x UART
- 2 x sPI
- I2C
- Micro SD card
- Analog channels: 8\_12 bit ADCs
- GPIO: Up to 24

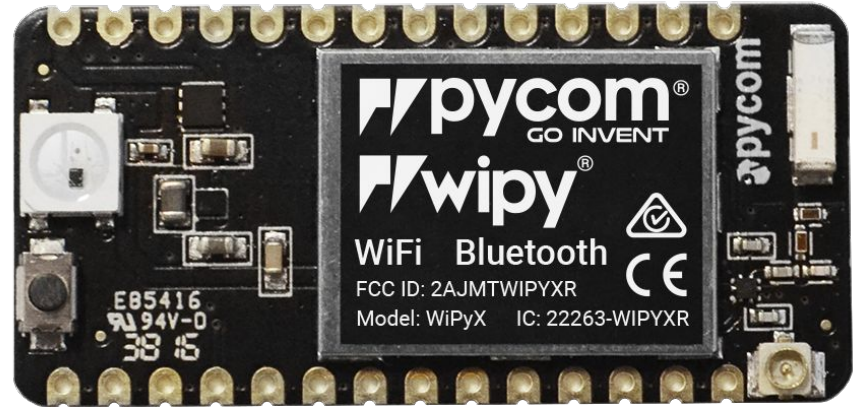



# Pysense & Pyscan Modules

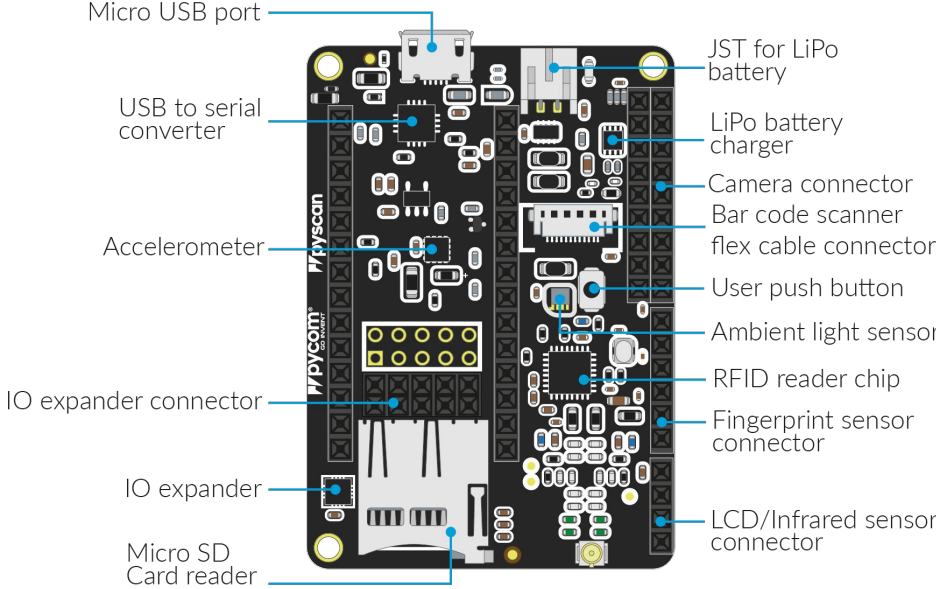
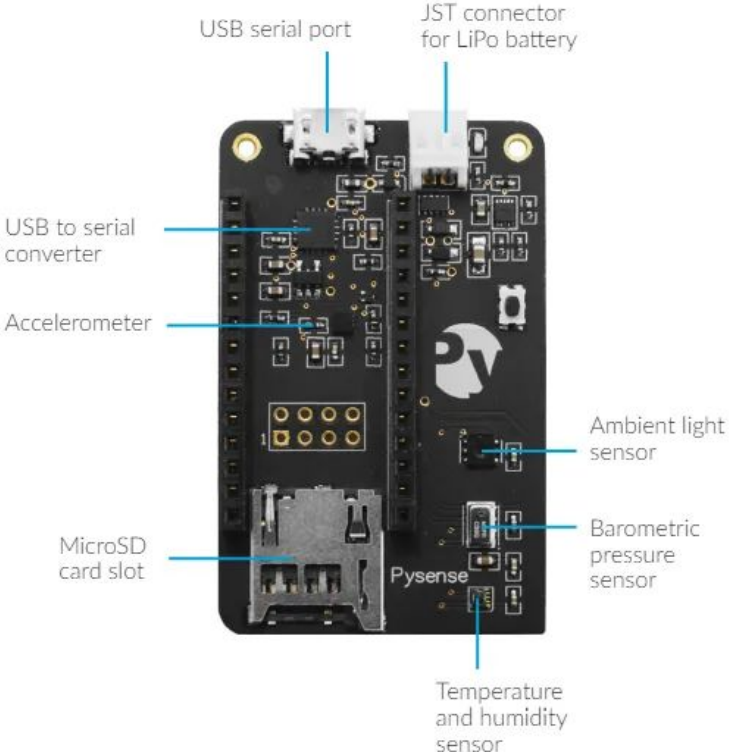

# Agenda

## The 5 Keys of understand IoT

- Why IoT is important
- What is IoT and what is not
- Who uses IoT and how
- When can IoT be a solution
- **Where can IoT be deployed**

[Break]

Case study analysis and discussion

Live demo of an IoT application



# In indoor and outdoor locations

An IoT node typically needs to be protected by a case from its surrounding environment and conditions.

Main scenarios are either indoor or outdoor conditions.

Cases are classified by a specific code known as the IP cod (Ingress Protection Code) that rates the degree of protection provided by mechanical casings and electrical enclosures against intrusion, dust, accidental contact, and water.

Outdoor cases for IoT often provide IP67 protection

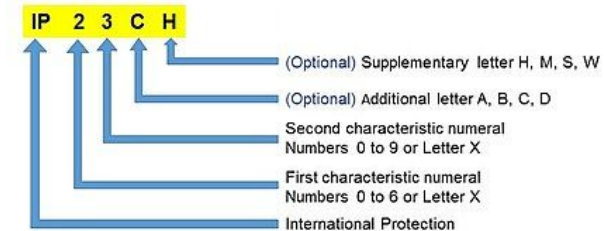
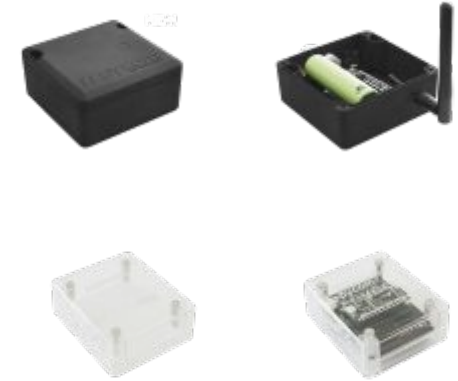

# IP Code

IP followed by a 4-digit code

First characteristic numeral: Solid particle protection

Second digit: Liquid ingress protection





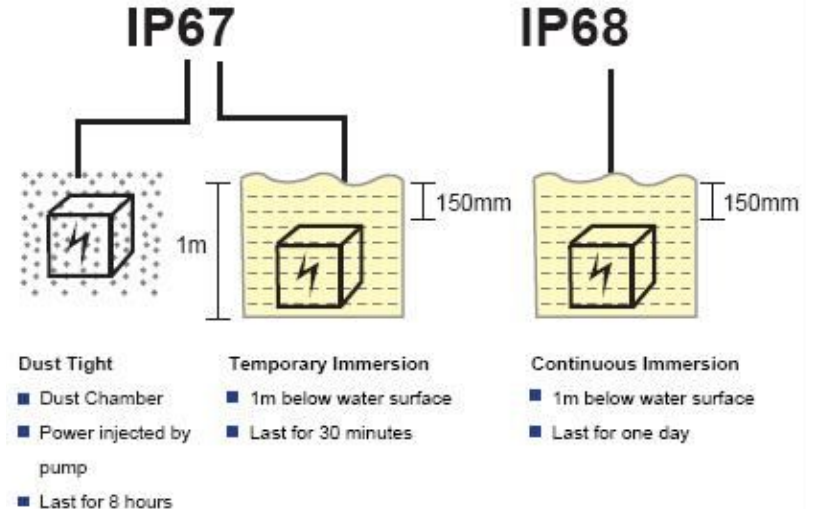
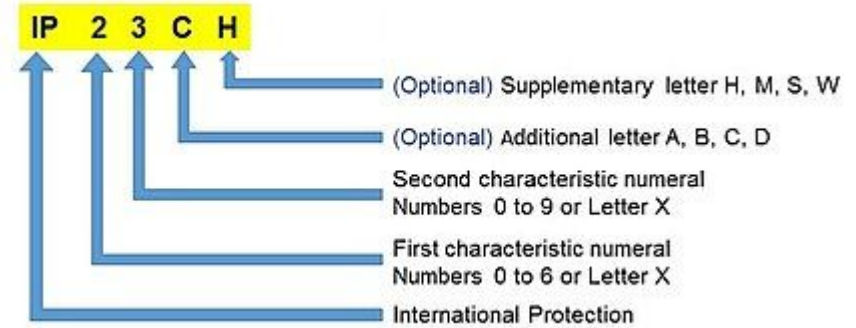

Additional letter: Other protections

Supplementary letter: Other protections

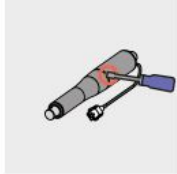

# IP Code Table

## Solids







1	2	3	4	5	6
					
Solid objects greater than 50 mm, such as the back of a hand.	Solid objects greater than 12.5 mm, such as a finger.	Solid objects greater than 2.5 mm, such as a screwdriver.	Solid objects greater than 1 mm, such as a wire.	Limited ingress of dust. It must not interfere with the actuator operation.	No ingress of dust.

## Codification example

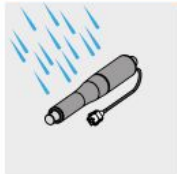

-  Ingress Protection
-  Solids
-  Liquids

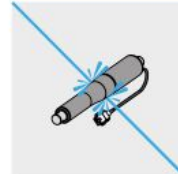
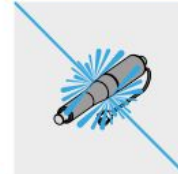
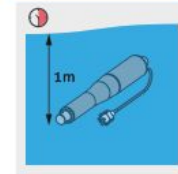
## Liquids

1	2	3	4	5	6	7	8
							
Vertically falling drops.	Vertically falling drops over an actuator tilted 15°.	Sprays of water at any angle up to 60° from the vertical.	Sprays of water at any angle.	Water jets.	Powerful water jets.	15cm-100 cm immersion during 30 min.	Immersion under harder conditions than in IPX7.

## In **unpowered** sites using batteries

Energy can be stored in batteries: its capacity is expressed in Wh in general or in Ah for electronic devices, typically as they assume a reference voltage.

Batteries can be split in two families: primary batteries which can not be recharged, and secondary cells which are rechargeable.

Batteries are generally composed of one or several cells, thus nominal voltage is given per cell technology.

Several cells in series yield a higher voltage (a multiple of the base nominal voltage), while several cells in parallel provide a greater current capability.

# Cell Technologies

Battery family	Technology	Chemical composition	$U_{\text{nom}}$ (V)
Primary	Alkaline	Zn-MnO <sub>2</sub>	1.5
	Lithium-Manganese-Dioxyde	Li-MnO <sub>2</sub>	3.0
	Lithium-Thionyl-Chloride	Li-SOCl <sub>2</sub>	3.6
Secondary	Nickel-Metal-Hybrid	Ni-MH	1.2
	Lead-Acid	Pb-SO <sub>4</sub>	2.1
	Lithium-Ion Cobalt-Oxide	Li-CoO <sub>2</sub>	3.7
	Lithium-Ion Iron-Phosphate	Li-FePO <sub>4</sub>	3.2
	Lithium-Ion Manganese-Oxide	Li-MnO <sub>2</sub>	3.9
	Lithium-Ion Sulfur	Li <sub>2</sub> S <sub>8</sub>	2.1
	Nickel-Cadmium	Ni-Cd	1.2
	Lithium-Polymer	Li-Po	3.7

# Capacity

Represents the quantity of energy contained in the battery, and allows the designer to estimate its operating time depending on the required power.

Capacity is expressed in Ah or mAh (1Ah = 1000 mAh), where 1Ah means providing a 1A continuous current for an hour at a specific voltage.

An accumulator with a capacity  $C$ , which provides a continuous current  $I$  will operate for a time  $t$  equal to  $C/I$  (since  $C = I \times t$ )

¿What technology is your phone battery? Voltage? Cells? Capacity? How much does your phone consume on average?



# Mass density

Ratio between the energy a battery provides and its **weight**, expressed in Wh/kg. The higher the mass density, the lighter the battery.

Battery family	Technology	Mass density (W.h.kg <sup>-1</sup> )
Primary	Alkaline	85 — 190
	Lithium-Manganese-Dioxyde	150 — 330
	Lithium-Thionyl-Chloride	700
Secondary	Nickel-Metal-Hybrid	30 — 80
	Lead-Acid	30 — 40
	Lithium-Ion Cobalt-Oxide	90 — 140
	Lithium-Ion Iron-Phosphate	90 — 130
	Lithium-Ion Manganese-Oxide	160
	Lithium-Ion Sulfur	300
	Nickel-Cadmium	40 — 60
	Lithium-Polymer	100 — 265

# Energy density

Ratio between energy capability and the **volume** of the battery, expressed in Wh/L  
The higher the energy density, the smaller the battery.

Battery family	Technology	Energy density (W.h.L <sup>-1</sup> )
Primary	Alkaline	250 — 430
	Lithium-Manganese-Dioxyde	300 — 710
	Lithium-Thionyl-Chloride	1200
Secondary	Nickel-Metal-Hybrid	140 — 300
	Lead-Acid	60 — 75
	Lithium-Ion Cobalt-Oxide	220 — 350
	Lithium-Ion Iron-Phosphate	350
	Lithium-Ion Manganese-Oxide	270
	Lithium-Ion Sulfur	400
	Nickel-Cadmium	50 — 150
	Lithium-Polymer	185 — 220

# Ageing

Capacity of rechargeable cells decreases with time: every time the accumulator is charged and discharged, its capacity decreases. Designed for a specific number of charge and discharges cycles.

Battery family	Technology	Cycles
Secondary	Nickel-Metal-Hybrid	1500
	Lead-Acid	500 — 800
	Lithium-Ion Cobalt-Oxide	1200
	Lithium-Ion Iron-Phosphate	1000 — 2000
	Lithium-Ion Manganese-Oxide	1200
	Lithium-Ion Sulfur	
	Nickel-Cadmium	2000
	Lithium-Polymer	300 — 500



# Battery Lifespan

Takes into account IoT node states: *sleep, acquisition and communication*

On each state, different current values are present

- Sleep (S): typically in the order of nA
- Acquisition (A): a few  $\mu$ A (depends on sensors)
- Communication (C): a few mA

In general, battery span can be approximated assuming only acquisition and communications currents, since sleep currents are very low.

# Acquisition Energy

Assume  $N_a$  acquisitions are required per day, each lasting  $T_a$  with a power consumption of  $P_a$

Hence, a typical day consumes  $N_a * T_a * P_a$  form the battery

For example, for  $N_a = 24*60$ ,  $T_a = 100$  ms,  $P_a = 5$  uA, then 0.72 mAh per day

Hence, we expect to spend over a year only 262.8 mAh for acquisition

A 1000 mAh battery will last then about 3.8 years

# Communication Energy

Assume  $N_c$  communications messages are required per day, each lasting  $T_c$  with a power consumption of  $P_c$

Hence, a typical day consumes  $N_c * T_c * P_c$  form the battery

For example, for  $N_a = 1$ ,  $T_a = 1$  s,  $P_a = 3$  mA, then 3 mAh

Hence, we expect to spend over a year only 1095 mAh for communication

A 1000 mAh battery will NOT last a full year then.

# Energy Harvesting

Typically, solar panels can be used for energy harvesting in IoT

Converts the electromagnetic energy of the sun into electrical energy. The total amount of solar energy over a given area per unit of time is known as *irradiance* and it is measured in watts per square meter ( $W/m^2$ ).

This energy is normally averaged over a period of time, so it is common to talk about total irradiance per hour, day or month.

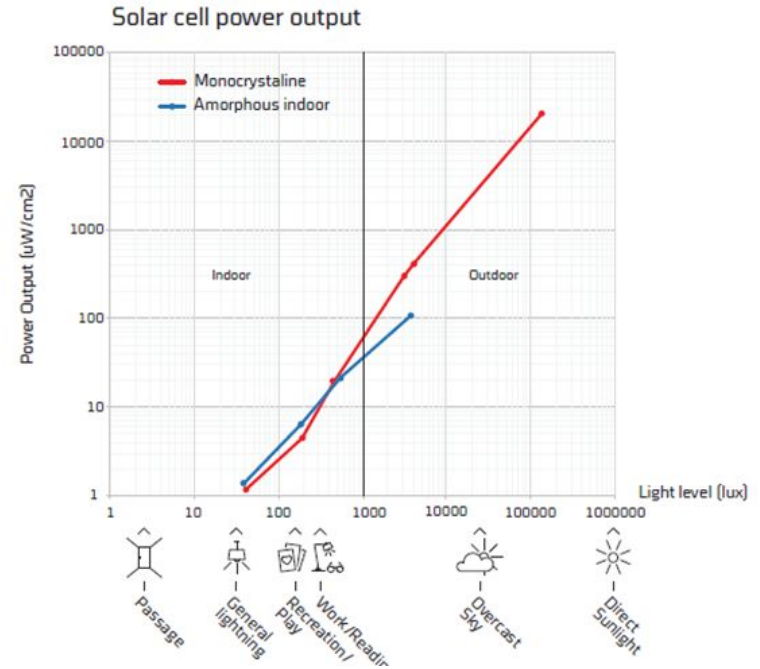

# In remote distant sites

Attribute	Bluetooth® Low Energy Technology	Wi-Fi	Z-Wave	IEEE 802.15.4 (Zigbee, Thread)	LTE-M	NB-IoT	Sigfox	LoRaWAN
Range	10 m – 1.5 km	15 m – 100 m	30 m - 50 m	30 m – 100 m	1 km – 10 km	1 km – 10 km	3 km – 50 km	2 km – 20 km
Throughput	125 kbps – 2 Mbps	54 Mbps – 1.3 Gbps	10 kbps – 100 kbps	20 kbps – 250 kbps	Up to 1 Mbps	Up to 200 kbps	Up to 100 bps	10 kbps – 50 kbps
Power Consumption	Low	Medium	Low	Low	Medium	Low	Low	Low
Ongoing Cost	One-time	One-time	One-time	One-time	Recurring	Recurring	Recurring	One-time
Module Cost	Under \$5	Under \$10	Under \$10	\$8-\$15	\$8-\$20	\$8-\$20	Under \$5	\$8-\$15
Topology	P2P, Star, Mesh, Broadcast	Star, Mesh	Mesh	Mesh	Star	Star	Star	Star



# Distance, Rate & Power Tradeoff

If distance increases,  
then either the rate decreases or the power increases

If the rate increases,  
then either the distance decreases or the power increases

If the power decreases,  
then either the rate or distance decreases

# Connected devices by communication technologies

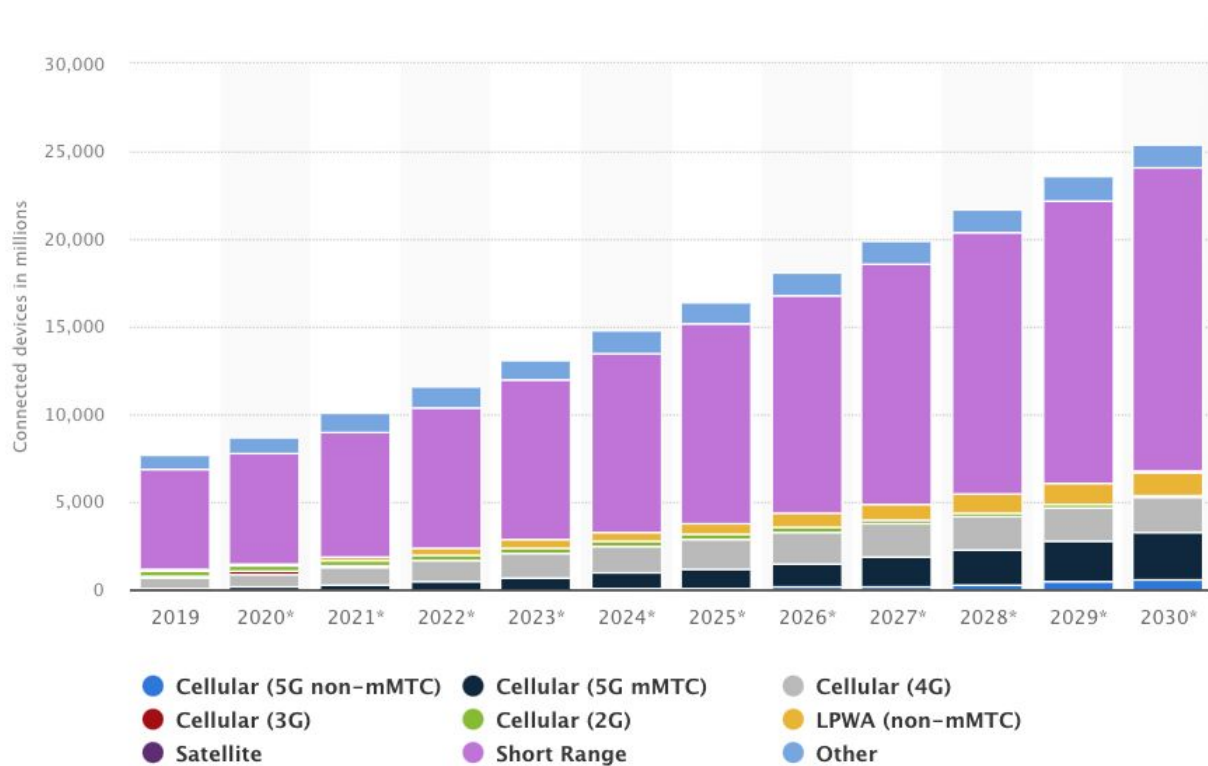

Data rate &  
Power Consumption

Cost: Low ● ● ● ● High

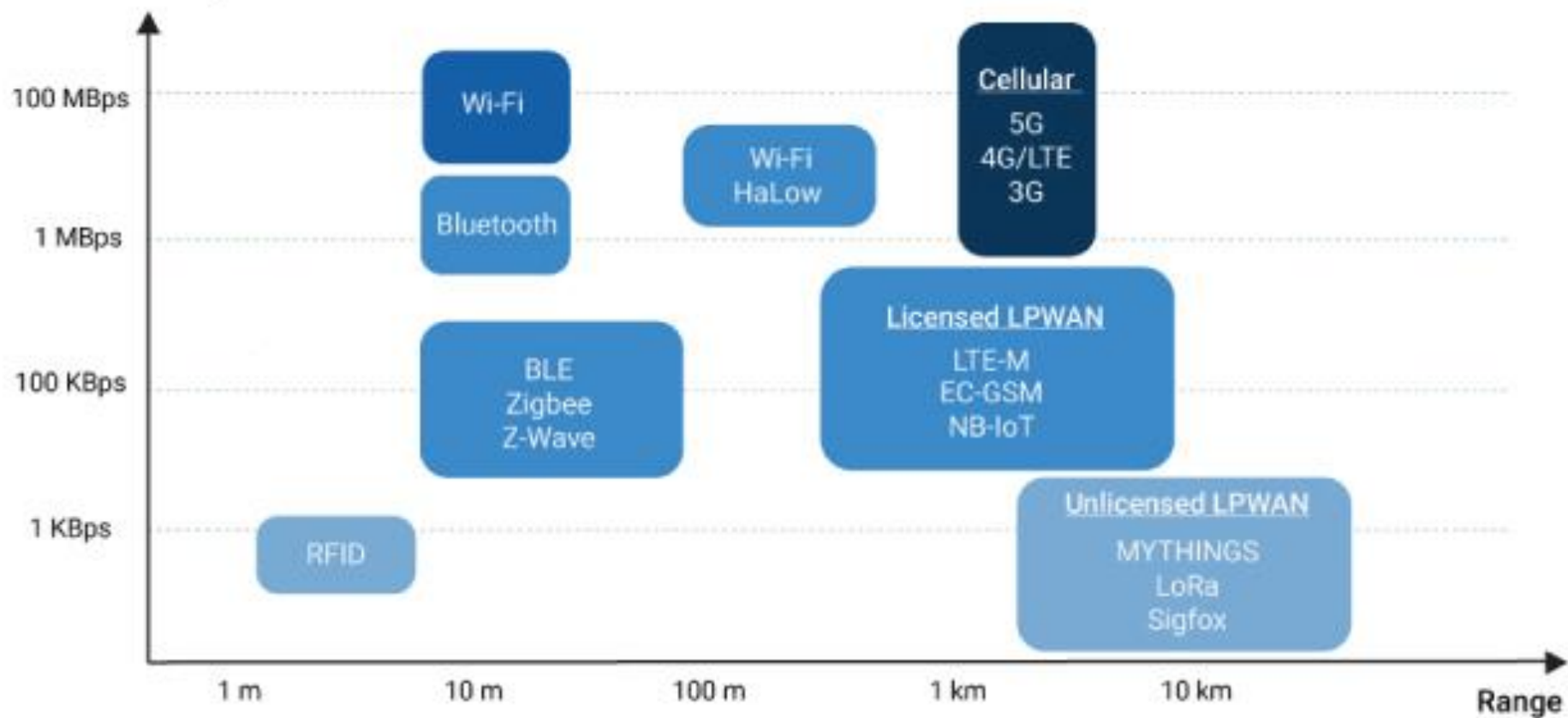

# Device-to-Device Communications

Devices that directly connect and communicate between one another, rather than through an intermediary application server.

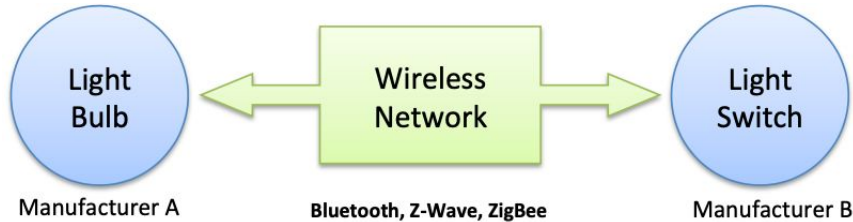

# Device-to-Cloud Communications

IoT device connects directly to an Internet cloud service like an application service provider to exchange data and control message traffic.

This approach frequently takes advantage of existing communications mechanisms like traditional wired Ethernet or Wi-Fi connections to establish a connection between the device and the IP network, which ultimately connects to the cloud service.

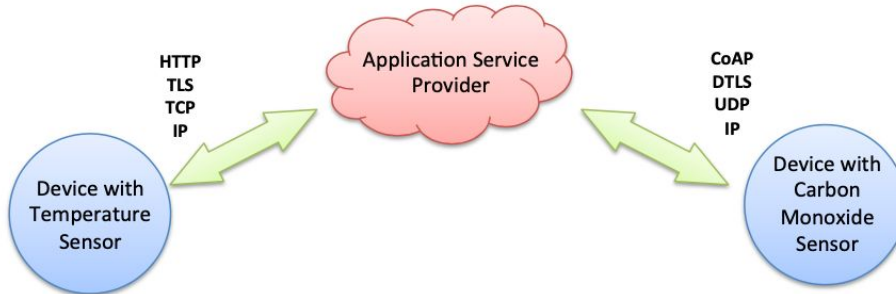

# Device-to-Gateway Model

IoT device connects through an gateway service as a conduit to reach a cloud service.

There is application software operating on a local gateway device, which acts as an intermediary between the device and the cloud service and provides security and other functionality such as data or protocol translation.

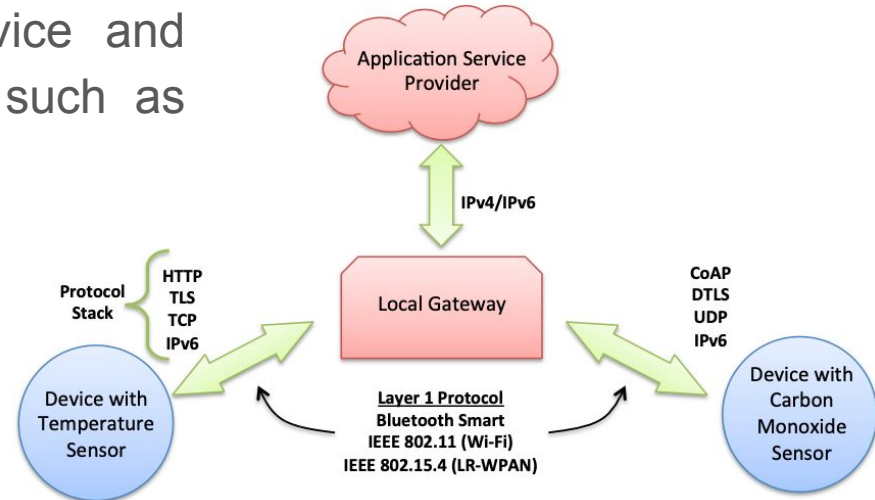

# IoT Communication Overview

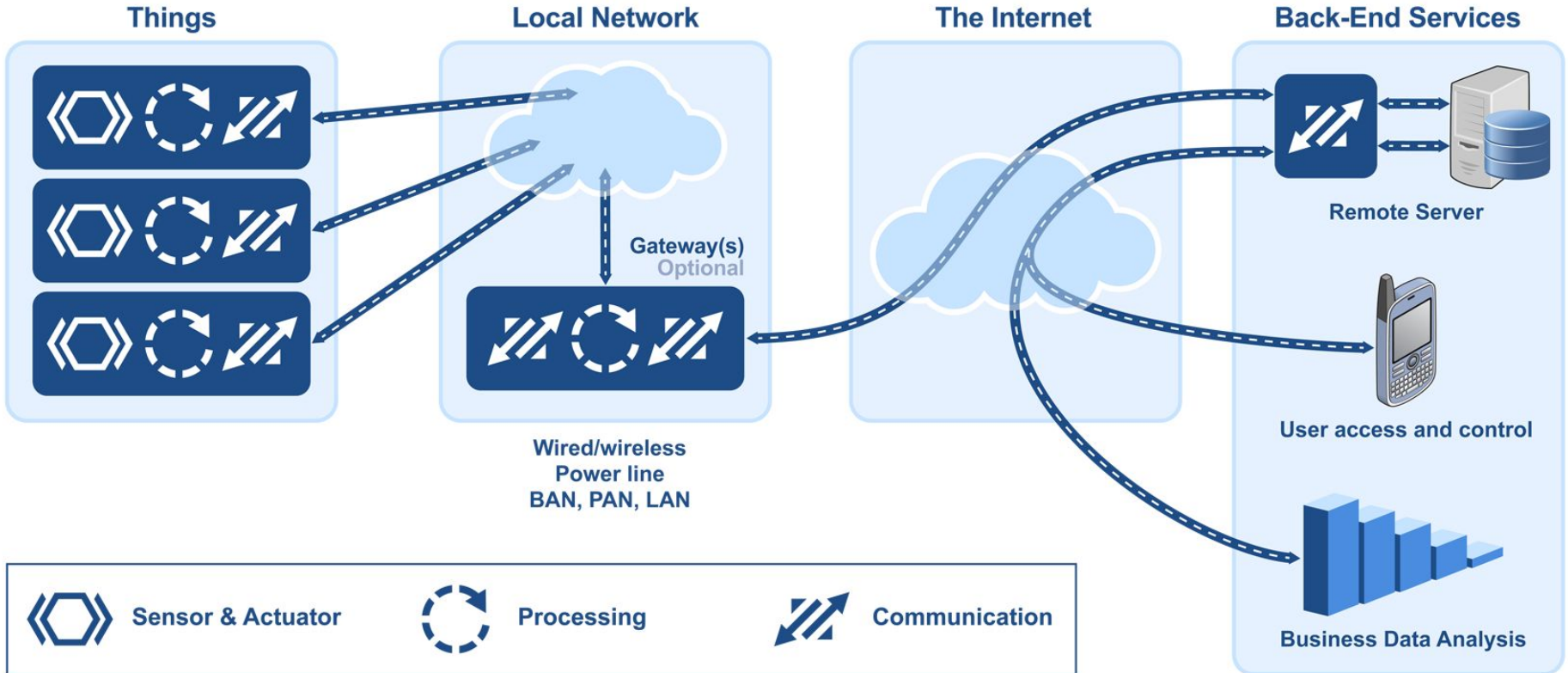

Key IoT Verticals	LPWAN (Star)	Cellular (Star)	Zigbee (Mostly Mesh)	BLE (Star & Mesh)	Wi-Fi (Star & Mesh)	RFID (Point-to-point)
Industrial IoT	●	○	○			
Smart Meter	●					
Smart City	●					
Smart Building	●		○	○		
Smart Home			●	●	●	
Wearables	○			●		
Connected Car					○	
Connected Health		●		●		
Smart Retail		○		●	○	●
Logistics & Asset Tracking	○	●				●
Smart Agriculture	●					



Highly applicable



Moderately applicable



# Global IoT market forecast (in billion connected IoT devices)

Number of global active IoT connections (installed base) in B

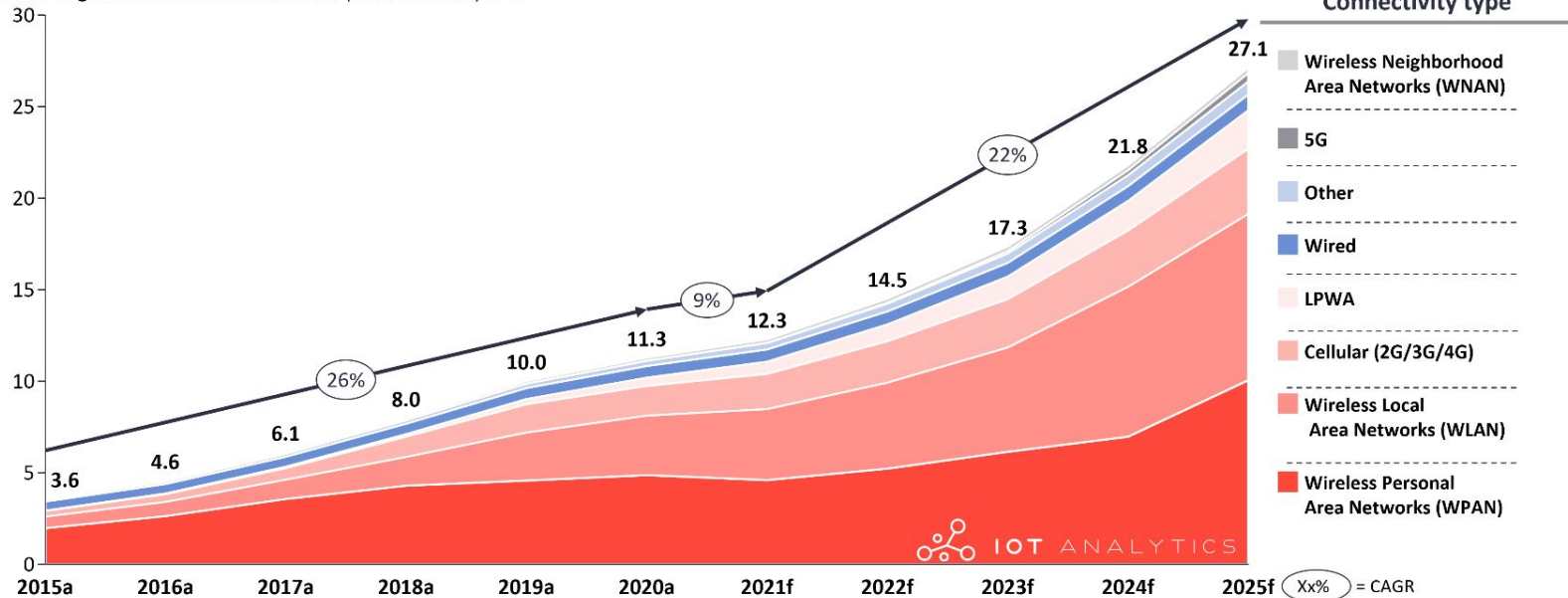

Note: IoT Connections do not include any computers, laptops, fixed phones, cellphones or tablets. Counted are active nodes/devices or gateways that concentrate the end-sensors, not every sensor/actuator. Simple one-directional communications technology not considered (e.g., RFID, NFC). Wired includes ethernet and fieldbuses (e.g., connected industrial PLCs or I/O modules). Cellular includes 2G, 3G, and 4G. LPWAN includes unlicensed and licensed low-power networks. WPAN includes Bluetooth, Zigbee, Z-Wave, or similar. WLAN includes Wi-Fi and related protocols. WNAN includes non-short-range mesh, such as Wi-SUN. Other includes satellite and unclassified proprietary networks with any range.

Source: IoT Analytics Research, September 2021 – Please remember to cite IoT Analytics as the source (with link) when re-sharing this content as per our copyright policy

# The Top 10 IoT Use Cases

**N= 1,640 IoT Projects**

Use Case	Type	Global Adoption <sup>1</sup>	Trend <sup>2</sup>
1			→
2			→
3			→
4			→
5			→
6			→
7			→
8			→
9			→
10			→

... of 48 use cases analyzed in total

**Note:1:** Share of companies that have at least partially rolled-out the use case **Note 2:** Based on respondents' indication of investment plan in in the next 2 years  
**Source:** IoT Analytics Research 2021, Conditions for republishing: Source citation with link to original post and company website; Non-commercial purposes only



Very strong investments expected in next 2 years



Moderate investments expected in next 2 years

# Agenda

## The 5 Keys of understand IoT

- Why IoT is important
- What is IoT and what is not
- Who uses IoT and how
- When can IoT be a solution
- Where can IoT be deployed

[Break]

## Case study analysis and discussion

Live demo of an IoT application



# Smart Building >> SmartRoom Case Study

Goal: manage efficiently use of rooms (classrooms, meeting rooms, offices, etc.) at our university

Monitor (Sensors):

- Presence of people (activity)
- Number of people (occupation)
- Open / Close door
- Lights / Temperature

Control (Actuators):

- Access
- Temperature / Lighting

Energy source / Indoor / Connectivity



# Agenda

## The 5 Keys of understand IoT

- Why IoT is important
- What is IoT and what is not
- Who uses IoT and how
- When can IoT be a solution
- Where can IoT be deployed

[Break]

Case study analysis and discussion

**Live demo of an IoT application**



# Demo Dashboard

Dashboard with 2 devices (phones)



# Demo App

Sensor Map for 3 devices that  
monitor their movement



# Claves de Éxito en IoT para la



# Transformación Digital

Jorge Finochietto  
*21 de abril de 2022*

